



Banchi da lavoro serie MG

Workbenches MG production | Etablis série MG

Banchi da lavoro serie MG

Workbenches MG production | *Etablis série MG*

COLORE *color* | *couleur*

standard

Blu RAL 5015



a richiesta

on request | *sur commande*

Grigio RAL 7035



I Banchi da Lavoro sono fra gli articoli storici nella produzione MG.

Da sempre rispondenti alle caratteristiche di robustezza e versatilità, oggi vedono ampliata la gamma della loro offerta con l'introduzione di nuovi modelli, nuovi piani di lavoro ed accessori.

I Banchi da lavoro della serie MG sono costruiti con una struttura particolarmente robusta, costituita da scatolari metallici di varie sezioni, di gambe provviste di piastre per il fissaggio a terra, di telaio perimetrale rinforzato posto sotto il piano di lavoro e provvisto di inserti per l'alloggiamento delle cassettiere. I piani di lavoro sono disponibili in due versioni: in lamiera spessore mm 3, in legno multistrato di faggio, spessore mm 35. I banchi possono essere accessoriati con kit elettrici, pneumatici e pannelli portattrezzi. Progettati per valorizzarne la versatilità, sono forniti sia nella versione:

- Monoblocco: banchi con struttura già montata e saldata
- Componibile: banchi, forniti in componenti da assemblare mediante bulloni, offrono la stessa robustezza dei banchi monoblocco facilitandone il trasporto e lo stoccaggio.

Workbenches are historical products in M.G. production.

They have always met the characteristics of sturdiness and versatility, and today their range is widened because of the introduction of new models, new work tops and optional. M.G. Workbenches have a special sturdy structure, made of metal profile with various sections, legs equipped with ground fastening plates, strengthened outside frame, which is placed under work surface and provided with holes for the housing of chests of drawers. Work tops are available in two versions: metal surfaces 3 mm thick and beech multilayer 35 mm thick.

Work tops can be equipped with electric, pneumatic kit and tool-holder panels.

Designed for versatility they are produced monobloc and modular.

Monobloc version: top with assembled and welded structure.

Modular tops: components to assemble by means of bolts. They offer the same sturdiness as the monobloc ones and make the transport and storage easier.

Les établis sont les produits historiques de M.G. Depuis toujours ils sont solides et universels, aujourd'hui la gamme des établis s'est enrichie grâce à des nouveaux modèles, nouveaux plateaux de travail et nouveaux outillages.

Les établis de la série MG ont une structure particulièrement solide, composée par des éléments métalliques de différentes sections, de pieds équipés avec des plaques de fixation à terre, de châssis périmètre renforcé placé sous le plateau de travail et percé pour le logement des caissons-tiroirs.

Les plateaux sont en deux versions: En métal - épaisseur 3 mm. En bois - multiplis de hêtre, épaisseur 35 mm. Les établis peuvent être équipés avec Prêt-à-monter électrique, pneumatique, et panneaux porte outillage. Les établis sont projetés en fonction de leur flexibilité, ils sont produits en version monobloc - établis assemblés et éléments soudés - et à éléments - à monter à moyen de boulons. Les établis à éléments sont ainsi robustes que ceux monoblocs, leur transport et stockage est plus simple.



Cassettiere per banchi da lavoro serie MG

Chests of drawers for workbenches line MG | Caissons-tiroirs pour etablis de travail MG

I banchi da lavoro serie MG sono dotati di tre tipologie di cassettiere, che vengono applicate, mediante bulloni, alla struttura in tubolare.

I cassetti scorrono su guide con cuscinetti ad estrazione totale ed hanno una portata di 60 kg.

Serratura a chiusura simultanea dei cassetti.

MG workbenches can be equipped with three different kind of chest of drawers which are bolt-fastened to the tubular structure.

The drawers slide on bearing guides and are equipped with a lock that allows to close all the drawers simultaneously.

Total extraction drawers with load capacity 60 kg

Les établis MG peuvent avoir 03 caisson à tiroirs, qui sont montés, en utilisant des boulons, sur la structure tubulaire.

Les tiroirs roulent sur de glissières à billes, ouverture totale, charge 60kg.

Serrure simultanée des tiroirs.

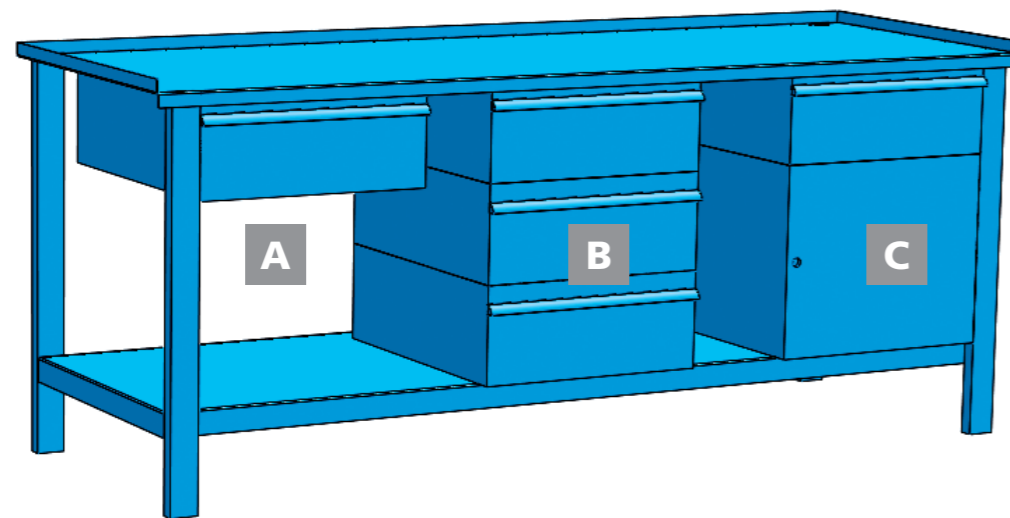

Esempio di composizione *Exemple of assembling / Exemple de composition*

In ogni banco si possono inserire varie combinazioni di cassettiere. In fase di ordine, per comporre il codice del prodotto, è sufficiente unire al codice della struttura vuota del banco, le lettere identificative del tipo di cassettiere scelte, come da schema.

Es. Banco monoblocco da mm. 2000 con piano lamiera (MG 103) con 1 cassettiere MG 116 (A), 1 cassettiere MG 117 (B), ed 1 cassettiere MG 118 (C), avrà il codice: **MG 103/ABC**



Each MG bench can be equipped with a combination of chests of drawers. To select the product correctly it is sufficient to specify the letter referred to the selected chest(s) of drawers (A,B,C), right after the numerical code of the bench.

*E.g.: 2000 mm monobloc bench with sheet metal top (MG103) with 1 drawer MG116 (A), 1 chest of drawers MG117 (B) and 1 chest of drawers MG118 (C) will have the code: **MG 103/ABC***

Pour chaque établi il y a la possibilité d'avoir différentes compositions des tiroirs. A la commande pour composer le code de l'article, est suffisant mettre le code de l'établi suivi par lettre identificatrice des tiroirs (comme dessus).

*Ex. établi monobloc mm 2000 plateau en tôle (MG103) avec tiroir MG116 (A), 03 caisson a tiroirs MG117 (B) et caisson porte e tiroir MG118 (C), le code finale est: **MG 103/ABC***

CASSETTIERE *chests of drawer / caissons-tiroirs*

	articolo		larghezza mm	profondità mm	altezza mm
	MG116	A Cassettiera ad 1 cassetto <i>Chest of drawers with 1 drawer Caissons-tiroirs avec 1 tiroir</i>	505	620	224
	MG117	B Cassettiera a 3 cassetti <i>Chest of drawers with 3 drawers Caissons-tiroirs avec 3 tiroirs</i>	505	620	600
	MG118	C Cassettiera ad 1 cassetto ed 1 vano con anta e pianetto interno rimovibile. <i>Chest of drawers with 1 drawer and 1 opening with door and removable inside shelf. Caissons-tiroirs avec 1 tiroirs et 1 embrasure avec volet et petite étagère interne amovible.</i>	505	620	600



Accessori per banchi da lavoro serie MG

Optionals for workbenches line MG | Accessoires pour etablis de travail MG

I banchi da lavoro sono predisposti per essere accessoriati con molti componenti. Oltre a vari tipi di pannelli e mobiletti portattrezzi, indicati nelle altre sezioni del catalogo, indichiamo qui di seguito alcuni accessori da applicare alla struttura.

The workbenches are prepared to be equipped with many elements. Beside various panels and tool-holder furniture, indicated in this catalogue, here follow some optionals to assemble on the structure.

Les etablis sont projetés pour être équipés avec plusieurs accessoires. En outre de différents panneaux et éléments porte outillage indiqués dans les autres sections du catalogue, ci-joint vous pouvez trouver des accessoires à fixer à la structure.

articolo	dotazione elettrica	dotazione pneumatica	larghezza mm	profondità mm	altezza mm
	<ul style="list-style-type: none"> • 1 interruttore magnetotermico tipo C 6KA 2P 16A 230V • 1 interruttore magnetotermico tipo C 6KA 3P 16A 400V • 2 prese 2P+T 16A 220V • 1 presa 3P+T 16A 380V <ul style="list-style-type: none"> • 1 magneto thermic switches type C6KA2P16A230V • 1 magneto thermic switch type C6KA3P 16A400V • 2 plugs 2P+T 16A220V • 1 plug 3P+T 16A380V <ul style="list-style-type: none"> • 1 interrupteur magneto thermique type C 6KA 2P 16A 230V • 1 interrupteur magneto thermique type C6KA3P 16A400V • 2 prises 2P+T 16A 220V • 1 prise 3P+T 16A 380V 	<p>riduttore di pressione con manometro e 2 prese rapide</p> <p><i>pressure reducer with gauge and 2 quick plugs</i></p> <p><i>réducteur de pression avec manomètre et 2 prises rapides</i></p>	110	56	600
	<ul style="list-style-type: none"> • 2 interruttori magnetotermici tipo C 6KA 2P 16A 230V • 1 presa 10/16A ita/ted 220V • 2 prese 2P+T 16A 220V <ul style="list-style-type: none"> • 2 magneto thermic switches type C6KA2P 16A230V • 1 plug 10/16A it/de 220 • 2 plugs 2P+T 16A220V <ul style="list-style-type: none"> • 2 interrupteurs magneto thermiques type C 6KA 2P 16A 230V • 1 prise 10/16A it/al 220V • 1 prise 2P+T 16A 220V • 1 prise 3P+T 16A 220V 	<p>riduttore di pressione con manometro e 2 prese rapide</p> <p><i>pressure reducer with gauge and 2 quick plugs</i></p> <p><i>réducteur de pression avec manomètre et 2 prises rapides</i></p>	110	56	600
	<p>Riduttore di pressione con manometro e 2 prese rapide</p> <p><i>Pressure reducer with gauge and 2 quick plugs</i></p> <p><i>Réducteur de pression avec manomètre et 2 prises rapides</i></p>	—	68	43	153

	articolo	larghezza mm	profondità mm
	MG 191	1000	700
	MG 192	1500	700
	MG 193	2000	700
	MG 194	2500	700
	MG 171	1000	700
	MG 172	1500	700
	MG 173	2000	700
	MG 174	2500	700



MG 101

Banchi monoblocco con piano in lamiera

Monobloc benches with sheet top | *Etablis monobloc avec plateau en tôle*

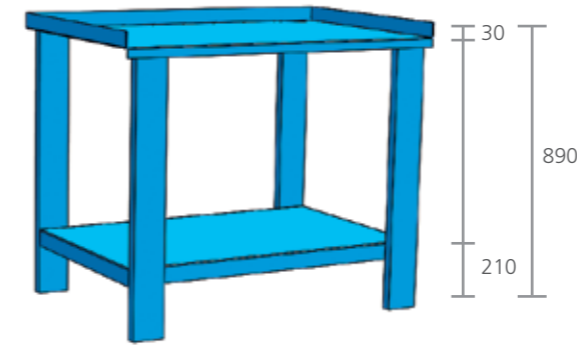

● **MG 101**
Banco senza cassetti
Bench without drawers |
Etablis sans tiroirs

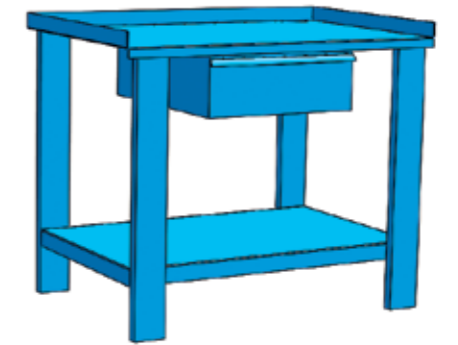

● **MG 101/A**
Banco dotato di 1 cassettera MG 116
Bench with 1 chest of drawers MG 116 |
Etabli avec un tiroir MG 116

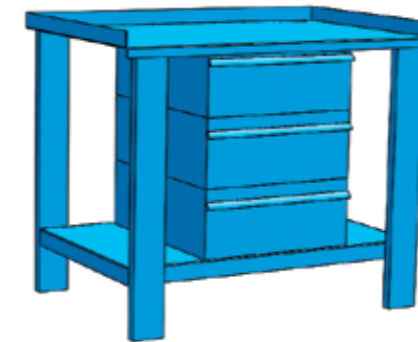

● **MG 101/B**
Banco dotato di 1 cassettera MG 117
Bench with 1 chest of drawers MG 117 |
Etabli avec un caisson a 3 tiroirs MG 117

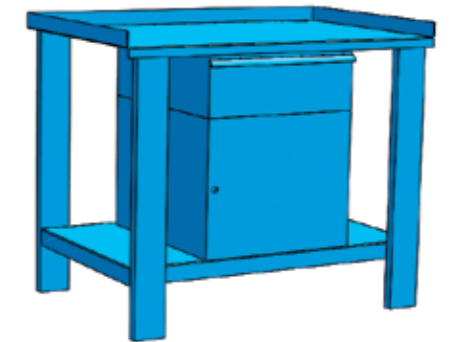

● **MG 101/C**
Banco dotato di 1 cassettera MG 118
Bench with 1 chest of drawers MG 118 |
Etabli avec un caisson MG 118

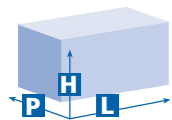

DIMENSIONI BANCO *bench dimensions / dimensions établi*

(L) larghezza 1000 mm	(P) profondità 700 mm	(H) altezza 890 mm
--------------------------	--------------------------	-----------------------

PORTATA *Load capacity / Charge* 1200 kg

MG 102

Banchi monoblocco con piano in lamiera

Monobloc benches with sheet top | *Etablis monobloc avec plateau en tôle*

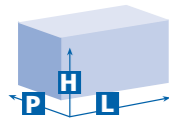

DIMENSIONI BANCO *bench dimensions / dimensions établi*

(L) larghezza 1500 mm	(P) profondità 700 mm	(H) altezza 890 mm
--------------------------	--------------------------	-----------------------

PORTATA *Load capacity / Charge* 800 kg



● **MG 102**
Banco senza cassetti
Bench without drawers |
Etablis sans tiroirs



● **MG 102/A**
Banco dotato di 1 cassettera MG 116
Bench with 1 chest of drawers MG 116 |
Etabli avec un tiroir MG 116



● **MG 102/B**
Banco dotato di 1 cassettera MG 117
Bench with 1 chest of drawers MG 117 |
Etabli avec un caisson MG 117



● **MG 102/C**
Banco dotato di 1 cassettera MG 118
Bench with 1 chest of drawers MG 118 |
Etabli avec un caisson MG 118



● **MG 102/AA**
Banco dotato di 2 cassette MG 116
Bench with 2 chests of drawers MG 116 |
Etabli avec 2 tiroirs MG 116

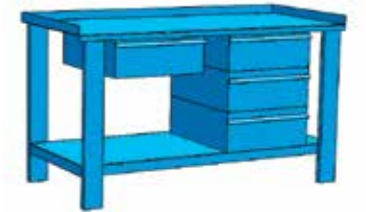

● **MG 102/AB**
Banco dotato di 1 cassettera MG 116
e 1 cassettera MG 117
*Bench with 1 chest of drawers MG 116 and
1 MG 117* | *Etabli avec 1 tiroir MG 116 et
caisson a tiroirs MG 117*

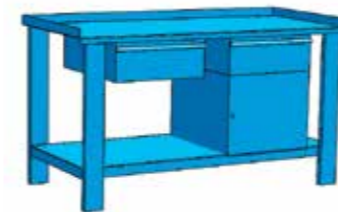

● **MG 102/AC**
Banco dotato di 1 cassettera MG 116
e 1 cassettera MG 118
*Bench with 1 chest of drawers MG 116 and
1 MG 118* | *Etabli avec 1 tiroir MG 116 et
1 caisson tiroir MG 118*



● **MG 102/BB**
Banco dotato di 2 cassette MG 117
Bench with 2 chests of drawers MG 117 |
Etabli avec 2 caisson MG 117

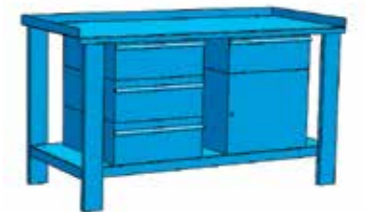

● **MG 102/BC**
Banco dotato di 1 cassettera MG 117
e 1 cassettera MG 118
*Bench with 1 chest of drawers MG 117 and
1 MG 118* | *Etabli avec 1 caisson MG 117
et 1 caisson MG 118*

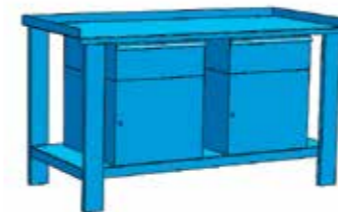

● **MG 102/CC**
Banco dotato di 2 cassette MG 118
Bench with 2 chests of drawers MG 118 |
Etabli avec 2 caissons MG 118

MG 103

Banchi monoblocco con piano in lamiera

Monobloc benches with sheet top | *Etablis monobloc avec plateau en tôle*

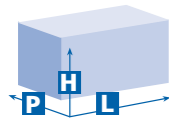

DIMENSIONI BANCO *bench dimensions / dimensions établi*

(L) larghezza 2000 mm	(P) profondità 700 mm	(H) altezza 890 mm
--------------------------	--------------------------	-----------------------

PORTATA *Load capacity / Charge* 500 kg

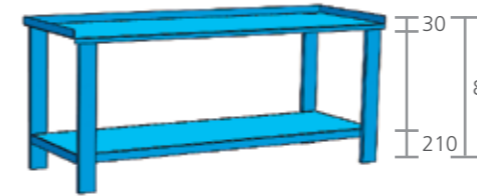

● **MG 103**
Banco senza cassetti
Bench without drawers |
Etablis sans tiroirs

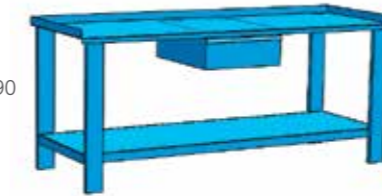

● **MG 103/A**
Banco dotato di 1 cassettera MG 116
Bench with 1 chest of drawers MG 116 |
Etabli avec un tiroir MG 116

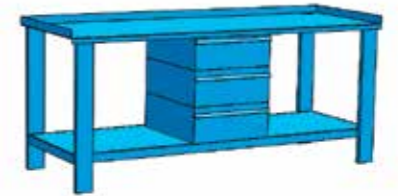

● **MG 103/B**
Banco dotato di 1 cassettera MG 117
Bench with 1 chest of drawers MG 117 |
Etabli avec un caisson MG 117

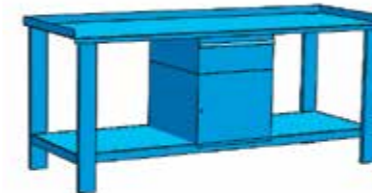

● **MG 103/C**
Banco dotato di 1 cassettera MG 118
Bench with 1 chest of drawers MG 118 |
Etabli avec un caisson MG 118

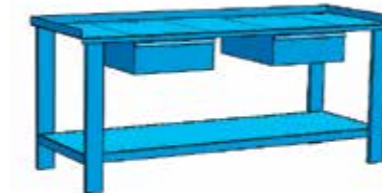

● **MG 103/AA**
Banco dotato di 2 cassettiere MG 116
Bench with 2 chests of drawers MG 116 |
Etabli avec 2 tiroirs MG 116

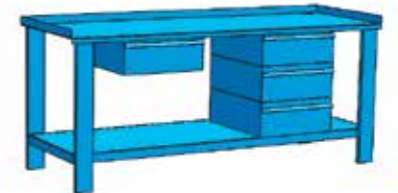

● **MG 103/AB**
Banco dotato di 1 cassettera MG 116
e 1 cassettera MG 117
*Bench with 1 chest of drawers MG 116 and
1 MG 117* | *Etabli avec 1 tiroir MG 116 et
caisson MG 117*

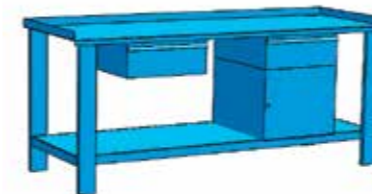

● **MG 103/AC**
Banco dotato di 1 cassettera MG 116
e 1 cassettera MG 118
*Bench with 1 chest of drawers MG 116 and
1 MG 118* | *Etabli avec 1 tiroir MG 116 et
caisson MG 118*

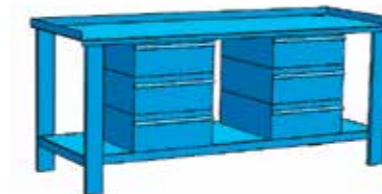

● **MG 103/BB**
Banco dotato di 2 cassettiere MG 117
Bench with 2 chests of drawers MG 117 |
Etabli avec 2 caissons MG 117

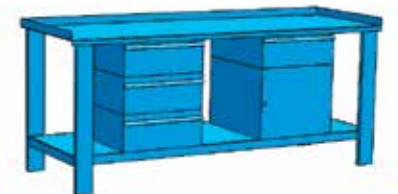

● **MG 103/BC**
Banco dotato di 1 cassettera MG 117
e 1 cassettera MG 118
*Bench with 1 chest of drawers MG 117 and
1 MG 118* | *Etabli avec caisson MG 117 et
1 caisson MG 118*

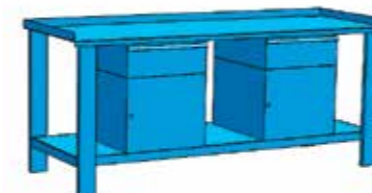

● **MG 103/CC**
Banco dotato di 2 cassettiere MG 118
Bench with 2 chests of drawers MG 118 |
Etabli avec 2 caissons MG 118



● **MG 103/AAA**
Banco dotato di 3 cassettiere MG 116
Bench with 3 chests of drawers MG 116 |
Etabli avec 3 tiroirs MG 116

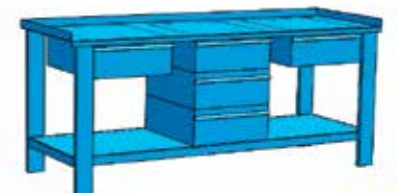

● **MG 103/ABA**
Banco dotato di 2 cassettiere MG 116
e 1 cassettera MG 117
*Bench with 2 chests of drawers MG 116
and 1 MG 117* | *Etabli avec 2 tiroirs MG
116 et caisson MG 117*

MG 104

Banchi monoblocco con piano in lamiera

Monobloc benches with sheet top | *Etablis monobloc avec plateau en tôle*

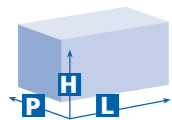

DIMENSIONI BANCO *bench dimensions / dimensions établi*

(L) larghezza 2500 mm	(P) profondità 700 mm	(H) altezza 890 mm
--------------------------	--------------------------	-----------------------

PORTATA *Load capacity / Charge* 1600 kg

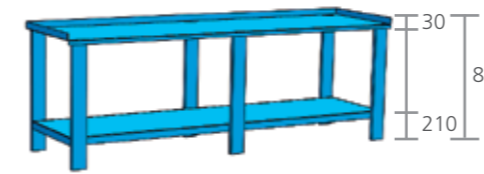

● **MG 104**
Banco senza cassetti
Bench without drawers |
Etablis sans tiroirs

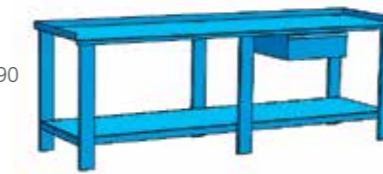

● **MG 104/A**
Banco dotato di 1 cassettera MG 116
Bench with 1 chest of drawers MG 116 |
Etabli avec un tiroir MG 116

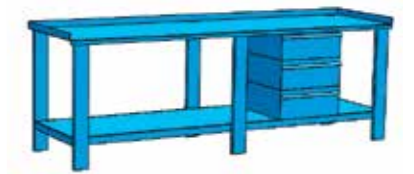

● **MG 104/B**
Banco dotato di 1 cassettera MG 117
Bench with 1 chest of drawers MG 117 |
Etabli avec un caisson MG 117

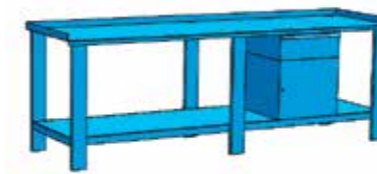

● **MG 104/C**
Banco dotato di 1 cassettera MG 118
Bench with 1 chest of drawers MG 118 |
Etabli avec un caisson MG 118

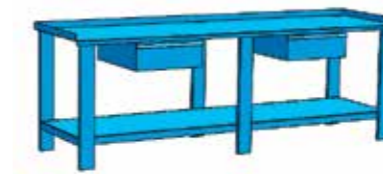

● **MG 104/AA**
Banco dotato di 2 cassettiere MG 116
Bench with 2 chests of drawers MG 116 |
Etabli avec 2 tiroirs MG 116

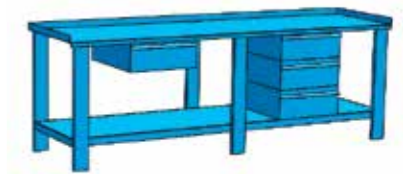

● **MG 104/AB**
Banco dotato di 1 cassettera MG 116
e 1 cassettera MG 117
*Bench with 1 chest of drawers MG 116 and
1 MG 117* | *Etabli avec 1 tiroir MG 116 et
caisson MG 117*

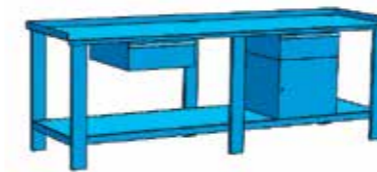

● **MG 104/AC**
Banco dotato di 1 cassettera MG 116
e 1 cassettera MG 118
*Bench with 1 chest of drawers MG 116 and
1 MG 118* | *Etabli avec 1 tiroir MG 116 et
caisson MG 118*

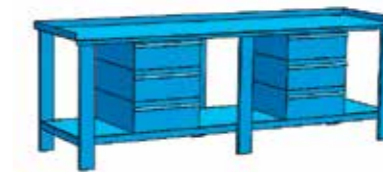

● **MG 104/BB**
Banco dotato di 2 cassettiere MG 117
Bench with 2 chests of drawers MG 117 |
Etabli avec 2 caissons MG 117

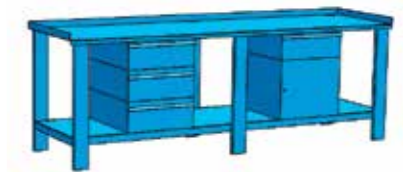

● **MG 104/BC**
Banco dotato di 1 cassettera MG 117
e 1 cassettera MG 118
*Bench with 1 chest of drawers MG 117 and
1 MG 118* | *Etabli avec caisson MG 117 et
caisson MG 118*

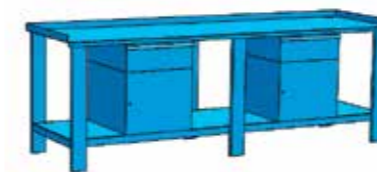

● **MG 104/CC**
Banco dotato di 2 cassettiere MG 118
Bench with 2 chests of drawers MG 118 |
Etabli avec 2 caissons MG 118

MG 105

Banchi monoblocco con piano in legno

Monobloc benches with top made of wood | *Etablis monobloc avec plateau en bois*

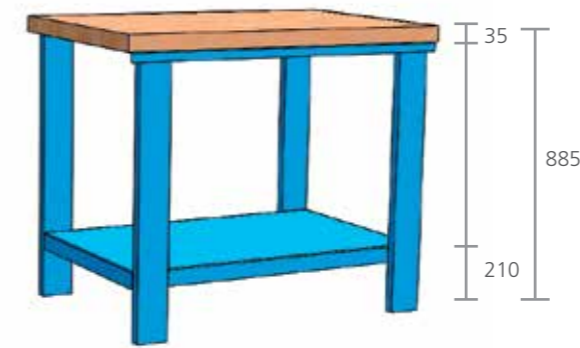

● **MG 105**
Banco senza cassetti
Bench without drawers |
Etablis sans tiroirs



● **MG 105/A**
Banco dotato di 1 cassettera MG 116
Bench with 1 chest of drawers MG 116 |
Etabli avec un tiroir MG 116

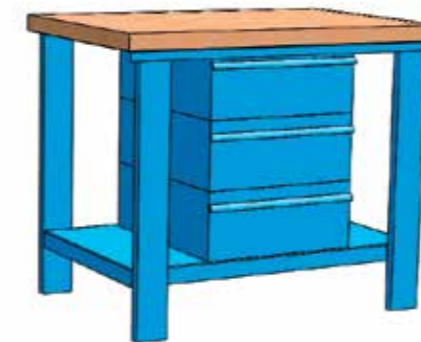

● **MG 105/B**
Banco dotato di 1 cassettera MG 117
Bench with 1 chest of drawers MG 117 |
Etabli avec un caisson MG 117



● **MG 105/C**
Banco dotato di 1 cassettera MG 118
Bench with 1 chest of drawers MG 118 |
Etabli avec un caisson MG 118

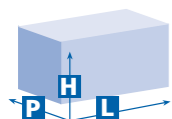

DIMENSIONI BANCO *bench dimensions / dimensions établi*

(L) larghezza 1000 mm	(P) profondità 700 mm	(H) altezza 885 mm
--------------------------	--------------------------	-----------------------

PORTATA *Load capacity / Charge* 1200 kg

MG 106

Banchi monoblocco con piano in legno

Monobloc benches with top made of wood | *Etablis monobloc avec plateau en bois*

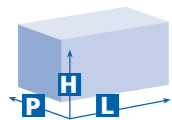

DIMENSIONI BANCO *bench dimensions / dimensions établi*

(L) larghezza 1500 mm	(P) profondità 700 mm	(H) altezza 885 mm
--------------------------	--------------------------	-----------------------

PORTATA *Load capacity / Charge* 800 kg



● **MG 106**
Banco senza cassetti
Bench without drawers |
Etablis sans tiroirs



● **MG 106/A**
Banco dotato di 1 cassettera MG 116
Bench with 1 chest of drawers MG 116 |
Etabli avec un tiroir MG 116

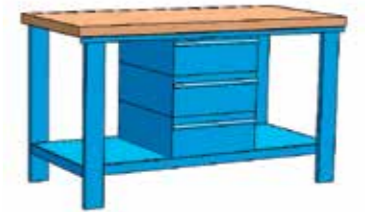

● **MG 106/B**
Banco dotato di 1 cassettera MG 117
Bench with 1 chest of drawers MG 117 |
Etabli avec un caisson MG 117



● **MG 106/C**
Banco dotato di 1 cassettera MG 118
Bench with 1 chest of drawers MG 118 |
Etabli avec un caisson MG 118



● **MG 106/AA**
Banco dotato di 2 cassettere MG 116
Bench with 2 chests of drawers MG 116 |
Etabli avec 2 tiroirs MG 116

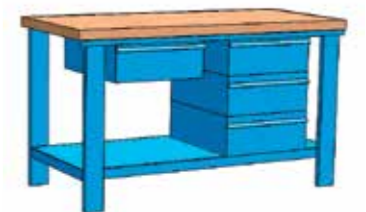

● **MG 106/AB**
Banco dotato di 1 cassettera MG 116
e 1 cassettera MG 117
*Bench with 1 chest of drawers MG 116 and
1 MG 117* | *Etabli avec 1 tiroir MG 116 et
caisson MG 117*



● **MG 106/AC**
Banco dotato di 1 cassettera MG 116
e 1 cassettera MG 118
*Bench with 1 chest of drawers MG 116 and
1 MG 118* | *Etabli avec 1 tiroir MG 116 et
caisson MG 118*



● **MG 106/BB**
Banco dotato di 2 cassettere MG 117
Bench with 2 chests of drawers MG 117 |
Etabli avec 2 caissons MG 117

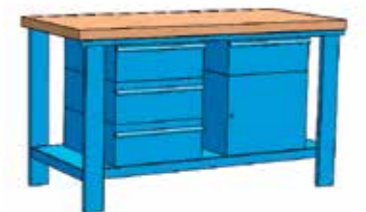

● **MG 106/BC**
Banco dotato di 1 cassettera MG 117
e 1 cassettera MG 118
*Bench with 1 chest of drawers MG 117 and
1 MG 118* | *Etabli avec caisson MG 117 et
caisson MG 118*



● **MG 106/CC**
Banco dotato di 2 cassettere MG 118
Bench with 2 chests of drawers MG 118 |
Etabli avec 2 caissons MG 118

MG 107

Banchi monoblocco con piano in legno

Monobloc benches with top made of wood | *Etablis monobloc avec plateau en bois*

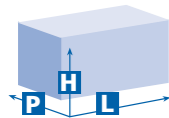

DIMENSIONI BANCO *bench dimensions / dimensions établi*

(L) larghezza 2000 mm	(P) profondità 700 mm	(H) altezza 885 mm
--------------------------	--------------------------	-----------------------

PORTATA *Load capacity / Charge* 500 kg

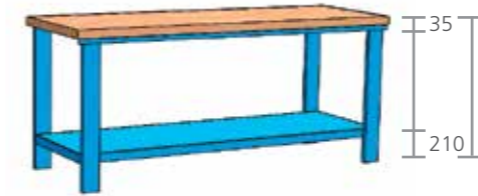

● **MG 107**
Banco senza cassetti
Bench without drawers |
Etablis sans tiroirs

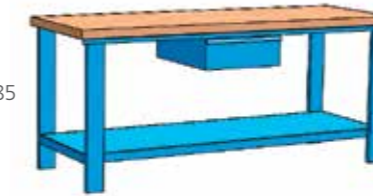

● **MG 107/A**
Banco dotato di 1 cassettera MG 116
Bench with 1 chest of drawers MG 116 |
Etabli avec un tiroir MG 116

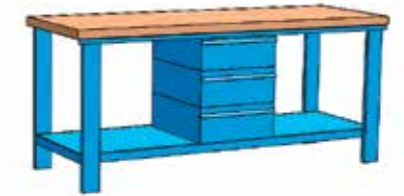

● **MG 107/B**
Banco dotato di 1 cassettera MG 117
Bench with 1 chest of drawers MG 117 |
Etabli avec un caisson MG 117

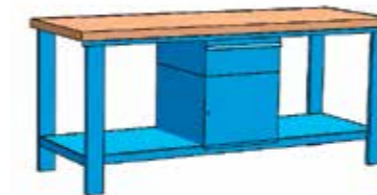

● **MG 107/C**
Banco dotato di 1 cassettera MG 118
Bench with 1 chest of drawers MG 118 |
Etabli avec un caisson MG 118

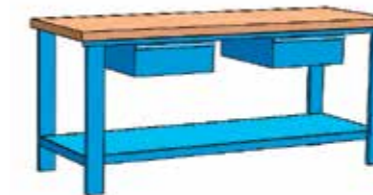

● **MG 107/AA**
Banco dotato di 2 cassettere MG 116
Bench with 2 chests of drawers MG 116 |
Etabli avec 2 tiroirs MG 116

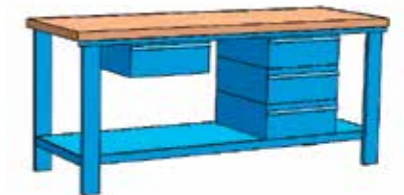

● **MG 107/AB**
Banco dotato di 1 cassettera MG 116
e 1 cassettera MG 117
*Bench with 1 chest of drawers MG 116 and
1 MG 117* | *Etabli avec 1 tiroir MG 116 et
caisson MG 117*

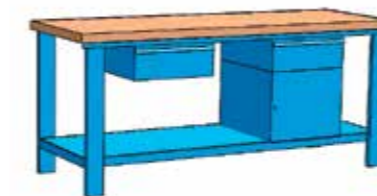

● **MG 107/AC**
Banco dotato di 1 cassettera MG 116
e 1 cassettera MG 118
*Bench with 1 chest of drawers MG 116 and
1 MG 118* | *Etabli avec 1 tiroir MG 116 et
caisson MG 118*

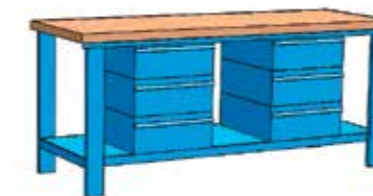

● **MG 107/BB**
Banco dotato di 2 cassettere MG 117
Bench with 2 chests of drawers MG 117 |
Etabli avec 2 caissons MG 117

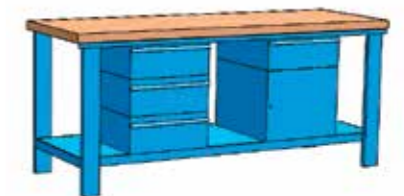

● **MG 107/BC**
Banco dotato di 1 cassettera MG 117
e 1 cassettera MG 118
*Bench with 1 chest of drawers MG 117 and
1 MG 118* | *Etabli avec caisson MG 117 et
caisson MG 118*

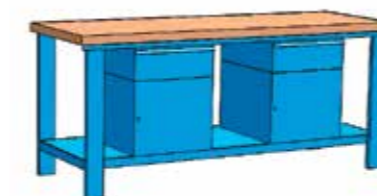

● **MG 107/CC**
Banco dotato di 2 cassettere MG 118
Bench with 2 chests of drawers MG 118 |
Etabli avec 2 caissons MG 118

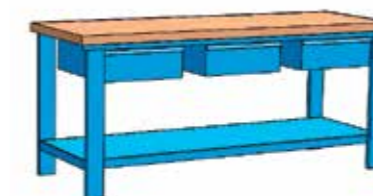

● **MG 107/AAA**
Banco dotato di 3 cassettere MG 116
Bench with 3 chests of drawers MG 116 |
Etabli avec 3 tiroirs MG 116

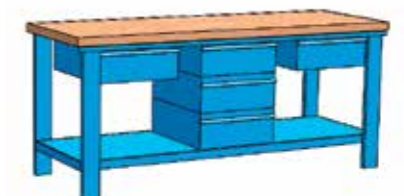

● **MG 107/ABA**
Banco dotato di 2 cassettere MG 116
e 1 cassettera MG 117
*Bench with 2 chests of drawers MG 116
and 1 MG 117* | *Etabli avec 2 tiroirs MG
116 et 1 caisson MG 117*

MG 108

Banchi monoblocco con piano in legno

Monobloc benches with top made of wood | *Etablis monobloc avec plateau en bois*

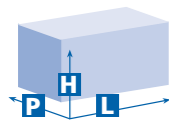

DIMENSIONI BANCO *bench dimensions / dimensions établi*

(L) larghezza 2500 mm	(P) profondità 700 mm	(H) altezza 885 mm
--------------------------	--------------------------	-----------------------

PORTATA *Load capacity / Charge* 1600 kg



● **MG 108**
Banco senza cassetti
Bench without drawers |
Etablis sans tiroirs

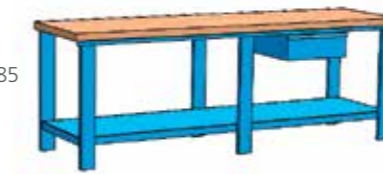

● **MG 108/A**
Banco dotato di 1 cassettera MG 116
Bench with 1 chest of drawers MG 116 |
Etabli avec un tiroir MG 116

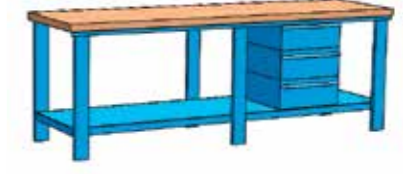

● **MG 108/B**
Banco dotato di 1 cassettera MG 117
Bench with 1 chest of drawers MG 117 |
Etabli avec un caisson MG 117

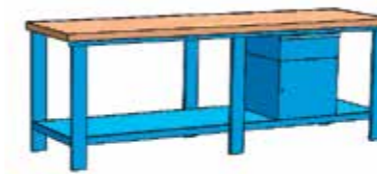

● **MG 108/C**
Banco dotato di 1 cassettera MG 118
Bench with 1 chest of drawers MG 118 |
Etabli avec un caisson MG 118

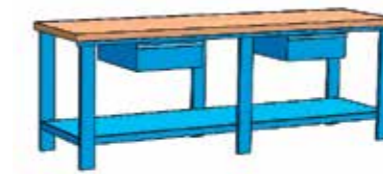

● **MG 108/AA**
Banco dotato di 2 cassettiere MG 116
Bench with 2 chests of drawers MG 116 |
Etabli avec 2 tiroirs MG 116

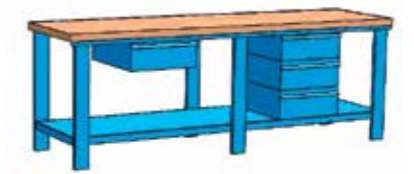

● **MG 108/AB**
Banco dotato di 1 cassettera MG 116
e 1 cassettera MG 117
*Bench with 1 chest of drawers MG 116 and
1 MG 117* | *Etabli avec 1 tiroir MG 116 et
caisson MG 117*

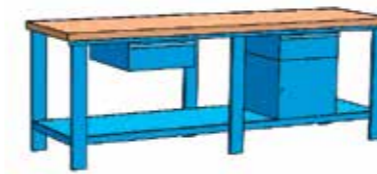

● **MG 108/AC**
Banco dotato di 1 cassettera MG 116
e 1 cassettera MG 118
*Bench with 1 chest of drawers MG 116 and
1 MG 118* | *Etabli avec 1 tiroir MG 116 et
caisson MG 118*



● **MG 108/BB**
Banco dotato di 2 cassettiere MG 117
Bench with 2 chests of drawers MG 117 |
Etabli avec 2 caissons MG 117

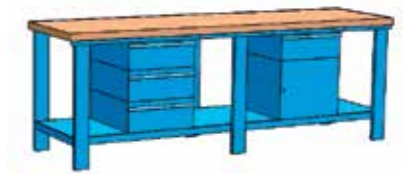

● **MG 108/BC**
Banco dotato di 1 cassettera MG 117
e 1 cassettera MG 118
*Bench with 1 chest of drawers MG 117 and
1 MG 118* | *Etabli avec caisson MG 117 et
caisson MG 118*

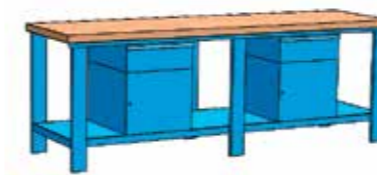

● **MG 108/CC**
Banco dotato di 2 cassettiere MG 118
Bench with 2 chests of drawers MG 118 |
Etabli avec 2 caissons MG 118

MG 142

Banco su ruote con piano in legno

Benches on wheels with top made of wood | *Etablis sur roues avec plateau en bois*

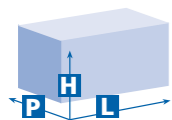

DIMENSIONI BANCO *bench dimensions / dimensions établi*

(L) larghezza 1000 mm	(P) profondità 700 mm	(H) altezza 905 mm
--------------------------	--------------------------	-----------------------

PORTATA *Load capacity / Charge* 450 kg

RUOTE *wheels / roues*

Ø 150 mm



● **MG 142**
Banco con ruote ø 150 mm,
(2 fisse e 2 girevoli con freno)
*Bench on wheels Ø150 mm (2 rigid and
2 swivel casters)* | *Etabli avec roues diam.
150mm (2 fixes et 2 pivotants avec frein)*



● **MG 142/A**
Banco con ruote ø 150 mm, (2 fisse e 2
girevoli con freno) dotato di 1 cassetiera
MG 116
*Bench on wheels Ø 150 mm (2 rigid and
2 swivel casters) equipped with 1 chest of
drawers MG 116* | *Etabli avec roues diam.
150mm (2 fixes et 2 pivotants avec frein)
avec un tiroir MG 116*



● **MG 142/B**
Banco con ruote ø 150 mm, (2 fisse e 2
girevoli con freno) dotato di 1 cassetiera
MG 117
*Bench on wheels Ø 150 mm (2 rigid and
2 swivel casters) equipped with 1 chest of
drawers MG 117* | *Etabli avec roues diam.
150mm (2 fixes et 2 pivotants avec frein)
avec un caisson MG 117*



● **MG 142/C**
Banco con ruote ø 150 mm, (2 fisse e 2
girevoli con freno) dotato di 1 cassetiera
MG 118
*Bench on wheels Ø 150 mm (2 rigid and
2 swivel casters) equipped with 1 chest of
drawers MG 118* | *Etabli avec roues diam.
150mm (2 fixes et 2 pivotants avec frein)
avec un caisson MG 118*



Banchi monoblocco pannellati

Monobloc benches equipped with panels | *Etablis monobloc avec panneaux*

COLORE *color* | *couleur*

standard	Blu RAL 5015
----------	--------------



● **MG109**
Banco con 2 cassetti e vano con ante. Piano di lavoro in lamiera
Bench equipped with 2 drawers and opening with doors. Work top made of sheet. | *Etablis avec 2 tiroirs et embrasure avec volet Plateau de travail en tôle.*
l. 1000 / p. 700 / h. 890 / portata 2000 kg



● **MG112**
Banco con 2 cassetti e vano laterale e inferiore chiuso da ante, piano in lamiera
Bench equipped with 2 drawers and side and lower opening closed with doors, top made of sheet. | *Etablis avec 2 tiroirs et embrasure latérale et inférieure fermé par volets, plateau en tôle.*
l. 1000 / p. 700 / h. 890 / portata 2000 kg



● **MG109/L**
Banco MG109 con piano di lavoro in legno
Bench MG109 with work top made of wood | *Etablis MG109 avec plateau de travail en bois*
l. 1000 / p. 700 / h. 885 / portata 2000 kg



● **MG112/L**
Banco MG112 con piano di lavoro in legno
Bench MG112 with work top made of wood | *Etablis MG112 avec plateau de travail en bois*
l. 1000 / p. 700 / h. 885 / portata 2000 kg



● **MG112/D**
Banco con 4 cassetti, 2 vani laterali e 2 vani inferiori chiusi da ante, piano in lamiera
Bench equipped with 4 drawers, 2 side openings and 2 lower openings closed with doors, top made of sheet. | *Etablis avec 4 tiroirs, 2 embrasures latérales et 2 embrasures inférieures fermées par volets. Plateau en tôle.*
l. 2000 / p. 700 / h. 890 / portata 1500 kg



● **MG112/DL**
Banco MG112/D con piano di lavoro in legno
Bench MG112/D with work top made of wood | *Etablis MG112/D avec plateau de travail en bois*
l. 2000 / p. 700 / h. 885 / portata 1500 kg



Banchi da lavoro componibili serie MG

Modular workbenches model MG | *Etablis à éléments série MG*

COLORE *color* | *couleur*

standard	Blu RAL 5015	a richiesta <i>on request</i> <i>sur commande</i>	Grigio RAL 7035
----------	--------------	--	-----------------

La serie MG dei banchi da lavoro è disponibile anche nella versione componibile. Una versione realizzata per facilitare il trasporto e lo stoccaggio dei banchi, mantenendone inalterata la solidità.

La struttura è realizzata in acciaio scartolato. L'assemblaggio dei componenti, di estrema semplicità, avviene mediante bulloni. I banchi componibili sono predisposti per l'inserimento degli stessi piani di lavoro, cassettiere ed accessori della versione monoblocco.

Workbenches MG production is also available in modular version. This version is designed to make the transport and storage of the benches easier, and to keep unchanged their sturdiness. The structure is made of steel. The assembling of the units, very easy, is carried out by means of bolts. Modular benches are prepared for the assembling of the same work tops, chests of drawers and optional in monobloc version.

La série MG des établis est disponible aussi dans la version à en kit. Une version réalisée pour faciliter le transport et le stockage des établis en gardant inchangée leur solidité. La structure est réalisée en acier. Le montage des éléments, très simple, est effectué par des boulons. Les établis en kit sont préparés pour le montage des mêmes plans de travail, chifonniers et accessoires de la version monobloc.

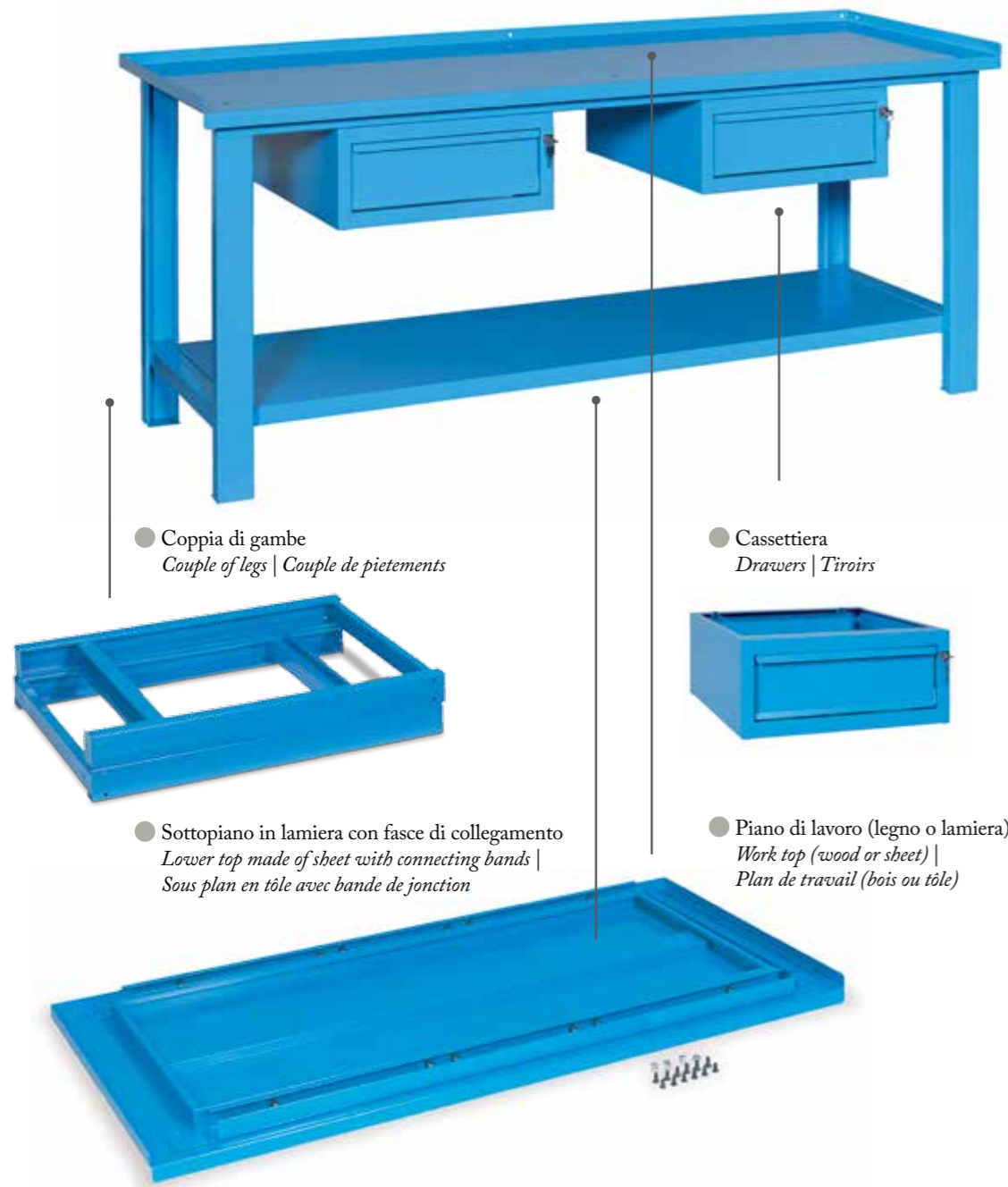

● Coppia di gambe
Couple of legs | *Couple de piétements*

● Cassettiera
Drawers | *Tiroirs*

● Sottopiano in lamiera con fasce di collegamento
Lower top made of sheet with connecting bands | *Sous plan en tôle avec bande de jonction*

● Piano di lavoro (legno o lamiera)
Work top (wood or sheet) | *Plan de travail (bois ou tôle)*

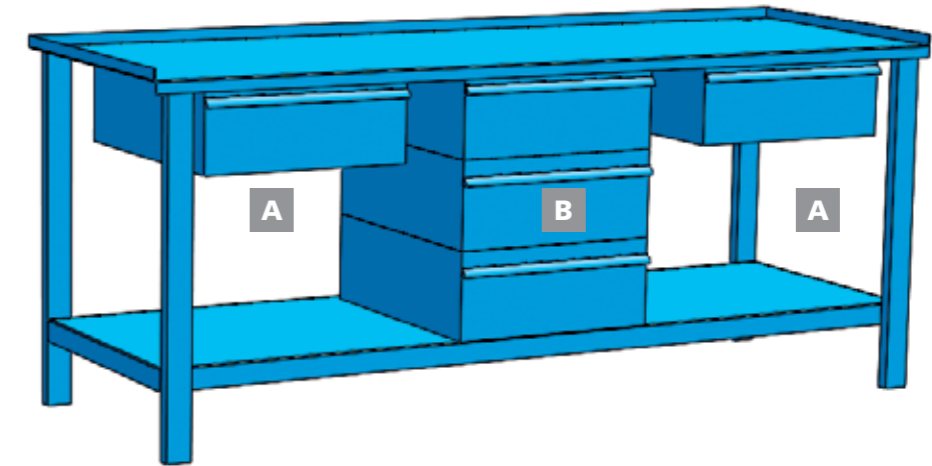

Esempio di composizione *Exemple of assembling* / *Exemple de composition*

Per comporre il codice dei banchi da lavoro componibili si ripete la stessa procedura utilizzata nei banchi monoblocco aggiungendo la lettera "S" al codice articolo. Es. Banco componibile da mm. 2000 con piano lamiera (MG 103S) con 2 cassettiere MG 116 (A) ed 1 cassetiera MG 117 (B) avrà il codice **MG103S/ABA**.

*To indicate the code of modular workbenches you have to follow the same procedure used for monobloc benches and add an "S" to the code of the product. E.g. Modular bench 2000 mm with top made of sheet (MG 103S) with 2 drawers MG 116 (A) and 1 drawer MG 117 (B) has the code **MG103S/ABA**.*

*Pour composer le code des établis à éléments il faut répéter la même procédure des établis monobloc, en ajoutant la lettre «S» au code du produit. Ex. Etablis à éléments de 2000 mm avec plan en tôle (MG 103S) avec 2 tiroirs MG 116 (A) et 1 tiroir MG 117 (B) a le code **MG103S/ABA**.*

CASSETTIERE *chests of drawer* / *caissons-tiroirs*

	articolo		larghezza mm	profondità mm	altezza mm
	MG116	A Cassettiera ad 1 cassetto <i>Chest of drawers with 1 drawer</i> <i>Caissons-tiroirs avec 1 tiroir</i>	505	620	224
	MG117	B Cassettiera a 3 cassetti <i>Chest of drawers with 3 drawers</i> <i>Caissons-tiroirs avec 3 tiroirs</i>	505	620	600
	MG118	C Cassettiera ad 1 cassetto ed 1 vano con anta e pianetto interno rimovibile. <i>Chest of drawers with 1 drawer and 1 opening with door and removable inside shelf.</i> <i>Caissons-tiroirs avec 1 tiroirs et 1 embrasure avec volet et petite étagère interne amovible.</i>	505	620	600

MG 101S

Banchi componibili con piano in lamiera

Modular benches with top made of sheet | *Etablis à élément avec plateau en tôle*

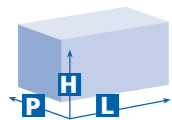

DIMENSIONI BANCO *bench dimensions / dimensions établi*

(L) larghezza 1000 mm	(P) profondità 700 mm	(H) altezza 890 mm
--------------------------	--------------------------	-----------------------

PORTATA *Load capacity / Charge* 1200 kg

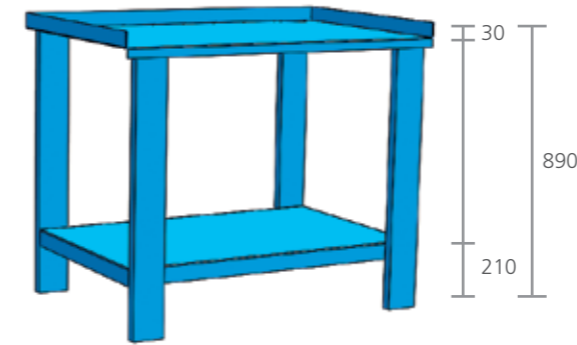

● **MG 101S**
Banco senza cassetti
Bench without drawers |
Etablis sans tiroirs

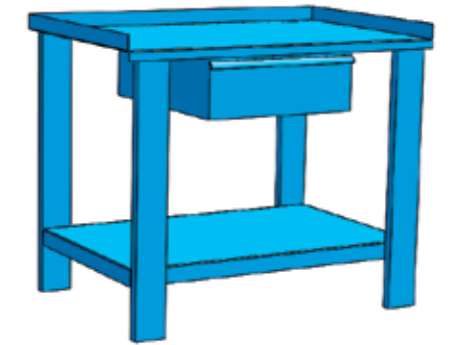

● **MG 101S/A**
Banco dotato di 1 cassettera MG 116
Bench with 1 chest of drawers MG 116 |
Etabli avec un tiroir MG 116

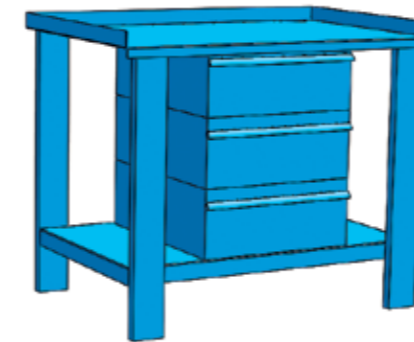

● **MG 101S/B**
Banco dotato di 1 cassettera MG 117
Bench with 1 chest of drawers MG 117 |
Etabli avec un caisson MG 117

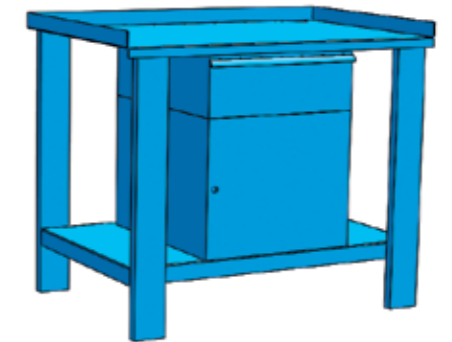

● **MG 101S/C**
Banco dotato di 1 cassettera MG 118
Bench with 1 chest of drawers MG 118 |
Etabli avec un caisson MG 118

MG 102S

Banchi componibili con piano in lamiera

Modular benches with top made of sheet | *Etablis à élément avec plateau en tôle*

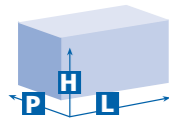

DIMENSIONI BANCO *bench dimensions / dimensions établi*

(L) larghezza 1500 mm	(P) profondità 700 mm	(H) altezza 890 mm
--------------------------	--------------------------	-----------------------

PORTATA *Load capacity / Charge* 800 kg



● **MG 102S**
Banco senza cassetti
Bench without drawers |
Etablis sans tiroirs



● **MG 102STR**
Banco con traversa poggiapiedi
Bench with footrest crossbar |
Etabli avec barre repose pieds



● **MG 102S/A**
Banco dotato di 1 cassettera MG 116
Bench with 1 chest of drawers MG 116 |
Etabli avec un tiroir MG 116



● **MG 102S/B**
Banco dotato di 1 cassettera MG 117
Bench with 1 chest of drawers MG 117 |
Etabli avec un caisson MG 117

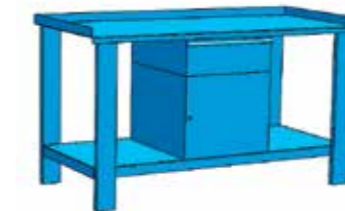

● **MG 102S/C**
Banco dotato di 1 cassettera MG 118
Bench with 1 chest of drawers MG 118 |
Etabli avec un caisson MG 118



● **MG 102S/AA**
Banco dotato di 2 cassette MG 116
Bench with 2 chests of drawers MG 116 |
Etabli avec 2 tiroirs MG 116

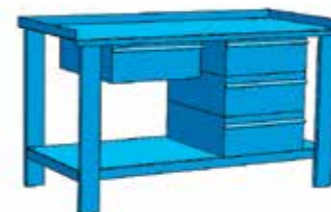

● **MG 102S/AB**
Banco dotato di 1 cassettera MG 116
e 1 cassettera MG 117
*Bench with 1 chest of drawers MG 116 and
1 MG 117* | *Etabli avec 1 tiroir MG 116 et
caisson MG 117*



● **MG 102S/AC**
Banco dotato di 1 cassettera MG 116
e 1 cassettera MG 118
*Bench with 1 chest of drawers MG 116 and
1 MG 118* | *Etabli avec 1 tiroir MG 116 et
caisson MG 118*



● **MG 102S/BB**
Banco dotato di 2 cassette MG 117
Bench with 2 chests of drawers MG 117 |
Etabli avec 2 caissons MG 117



● **MG 102S/BC**
Banco dotato di 1 cassettera MG 117
e 1 cassettera MG 118
*Bench with 1 chest of drawers MG 117 and
1 MG 118* | *Etabli avec caisson MG 117 et
caisson MG 118*

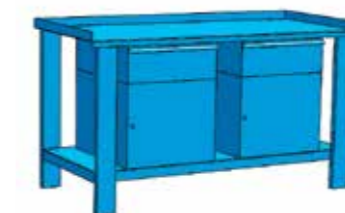

● **MG 102S/CC**
Banco dotato di 2 cassette MG 118
Bench with 2 chests of drawers MG 118 |
Etabli avec 2 caissons MG 118

MG 103S

Banchi componibili con piano in lamiera

Modular benches with top made of sheet | *Etablis à élément avec plateau en tôle*

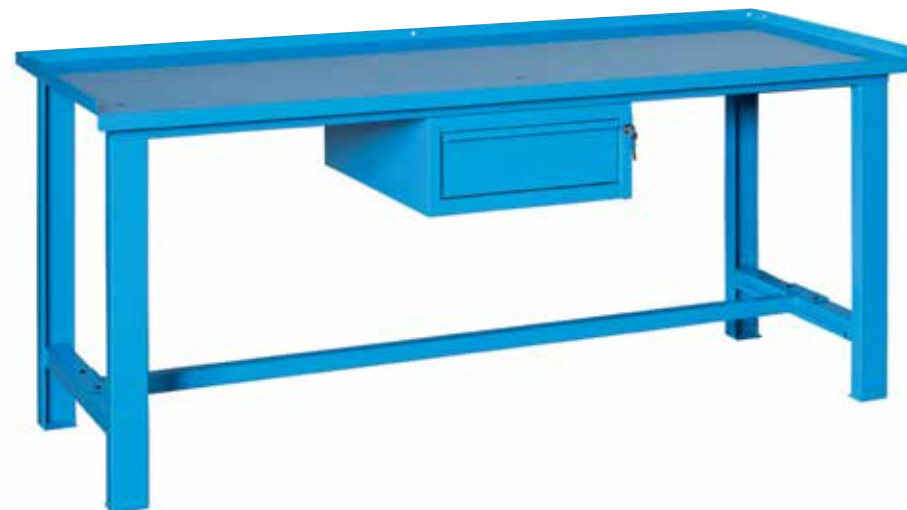

● **MG 103STR/A**
Banco dotato di 1 cassetteria MG 116 e traversa poggiapiedi.
Bench with 1 chest of drawers MG 116 and footrest crossbar | *Etabli avec un tiroir MG 116 et une barre repose pieds*

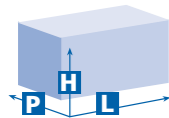

DIMENSIONI BANCO *bench dimensions / dimensions établi*

(L) larghezza 2000 mm	(P) profondità 700 mm	(H) altezza 890 mm
--------------------------	--------------------------	-----------------------

PORTATA *Load capacity / Charge* 500 kg

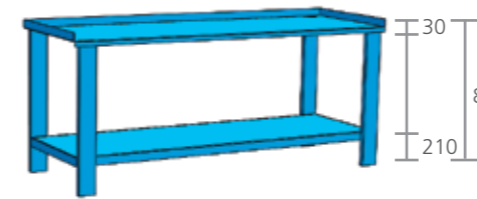

● **MG 103S**
Banco senza cassetti
Bench without drawers | *Etablis sans tiroirs*

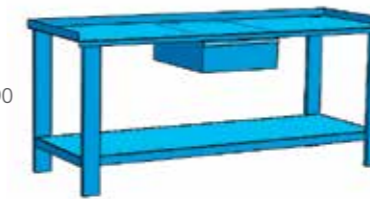

● **MG 103S/A**
Banco dotato di 1 cassetteria MG 116
Bench with 1 chest of drawers MG 116 | *Etabli avec un tiroir MG 116*

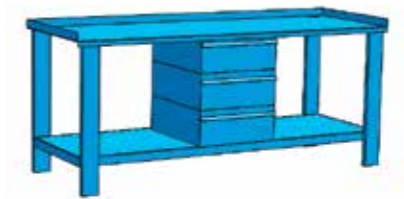

● **MG 103S/B**
Banco dotato di 1 cassetteria MG 117
Bench with 1 chest of drawers MG 117 | *Etabli avec un caisson MG 117*

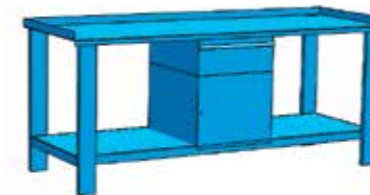

● **MG 103S/C**
Banco dotato di 1 cassetteria MG 118
Bench with 1 chest of drawers MG 118 | *Etabli avec un caisson MG 118*

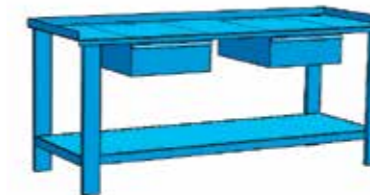

● **MG 103S/AA**
Banco dotato di 2 cassette MG 116
Bench with 2 chests of drawers MG 116 | *Etabli avec 2 tiroirs MG 116*

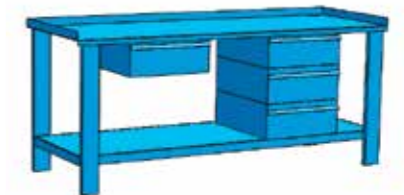

● **MG 103S/AB**
Banco dotato di 1 cassetteria MG 116 e 1 cassetteria MG 117
Bench with 1 chest of drawers MG 116 and 1 MG 117 | *Etabli avec 1 tiroir MG 116 et caisson MG 117*

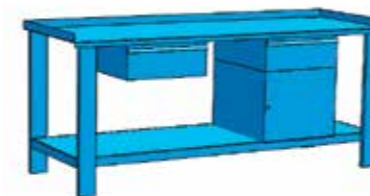

● **MG 103S/AC**
Banco dotato di 1 cassetteria MG 116 e 1 cassetteria MG 118
Bench with 1 chest of drawers MG 116 and 1 MG 118 | *Etabli avec 1 tiroir MG 116 et caisson MG 118*

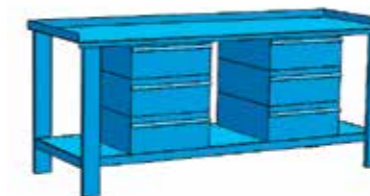

● **MG 103S/BB**
Banco dotato di 2 cassette MG 117
Bench with 2 chests of drawers MG 117 | *Etabli avec 2 caissons a 3 tiroirs MG 117*

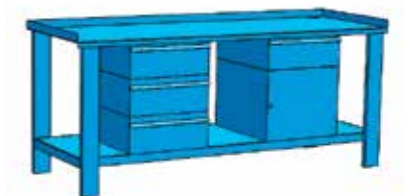

● **MG 103S/BC**
Banco dotato di 1 cassetteria MG 117 e 1 cassetteria MG 118
Bench with 1 chest of drawers MG 117 and 1 MG 118 | *Etabli avec 1 caisson a 3 tiroirs MG 117 et caisson MG 118*

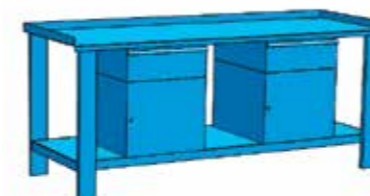

● **MG 103S/CC**
Banco dotato di 2 cassette MG 118
Bench with 2 chests of drawers MG 118 | *Etabli avec 2 caissons MG 118*

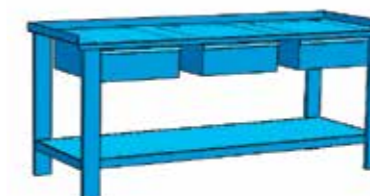

● **MG 103S/AAA**
Banco dotato di 3 cassette MG 116
Bench with 3 chests of drawers MG 116 | *Etabli avec 3 tiroirs MG 116*

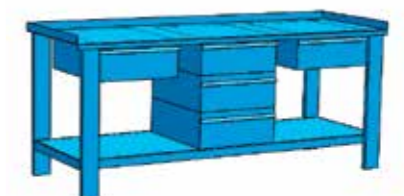

● **MG 103S/ABA**
Banco dotato di 2 cassette MG 116 e 1 cassetteria MG 117
Bench with 2 chests of drawers MG 116 and 1 MG 117 | *Etabli avec 2 tiroirs MG 116 et caisson MG 117*

MG 105S

Banchi componibili con piano in legno

Modular benches with top made of wood | *Etablis à élément avec plateau en bois*

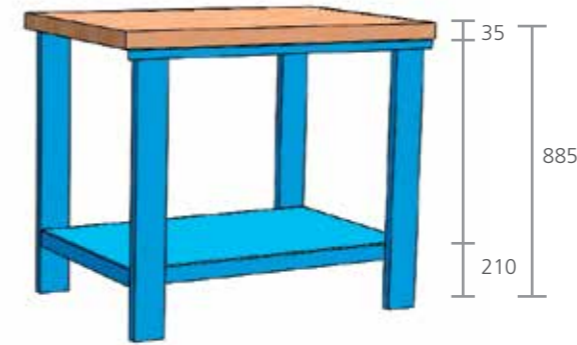

● **MG 105S**
Banco senza cassetti
Bench without drawers |
Etablis sans tiroirs



● **MG 105S/A**
Banco dotato di 1 cassettera MG 116
Bench with 1 chest of drawers MG 116 |
Etabli avec un tiroir MG 116



● **MG 105S/B**
Banco dotato di 1 cassettera MG 117
Bench with 1 chest of drawers MG 117 |
Etabli avec un caisson MG 117



● **MG 105S/C**
Banco dotato di 1 cassettera MG 118
Bench with 1 chest of drawers MG 118 |
Etabli avec un caisson MG 118

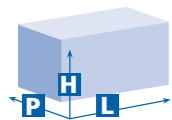

DIMENSIONI BANCO *bench dimensions / dimensions établi*

(L) larghezza 1000 mm	(P) profondità 700 mm	(H) altezza 885 mm
--------------------------	--------------------------	-----------------------

PORTATA *Load capacity / Charge* 1200 kg

MG 106S

Banchi componibili con piano in legno

Modular benches with top made of wood | *Etablis à élément avec plateau en bois*

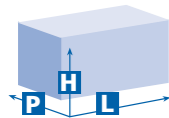

DIMENSIONI BANCO *bench dimensions / dimensions établi*

(L) larghezza 1500 mm	(P) profondità 700 mm	(H) altezza 885 mm
--------------------------	--------------------------	-----------------------

PORTATA *Load capacity / Charge* 800 kg



● **MG 106S**
Banco senza cassetti
Bench without drawers |
Etablis sans tiroirs



● **MG 106STR**
Banco dotato di traversa poggiapiedi
Bench with footrest crossbar |
Etabli avec barre repose pieds



● **MG 106S/A**
Banco dotato di 1 cassettera MG 116
Bench with 1 chest of drawers MG 116 |
Etabli avec un tiroir MG 116

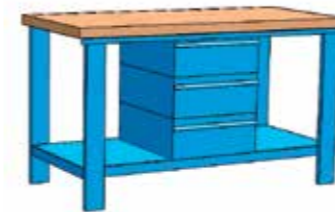

● **MG 106S/B**
Banco dotato di 1 cassettera MG 117
Bench with 1 chest of drawers MG 117 |
Etabli avec un caisson MG 117

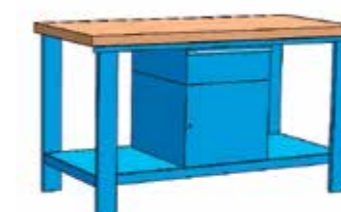

● **MG 106S/C**
Banco dotato di 1 cassettera MG 118
Bench with 1 chest of drawers MG 118 |
Etabli avec un caisson MG 118



● **MG 106S/AA**
Banco dotato di 2 cassette MG 116
Bench with 2 chests of drawers MG 116 |
Etabli avec 2 tiroirs MG 116

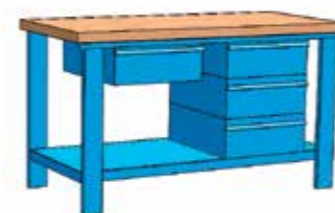

● **MG 106S/AB**
Banco dotato di 1 cassettera MG 116
e 1 cassettera MG 117
*Bench with 1 chest of drawers MG 116 and
1 MG 117* | *Etabli avec 1 tiroir MG 116 et
caisson MG 117*

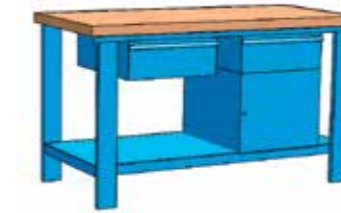

● **MG 106S/AC**
Banco dotato di 1 cassettera MG 116
e 1 cassettera MG 118
*Bench with 1 chest of drawers MG 116 and
1 MG 118* | *Etabli avec 1 tiroir MG 116 et
caisson MG 118*



● **MG 106S/BB**
Banco dotato di 2 cassette MG 117
Bench with 2 chests of drawers MG 117 |
Etabli avec 2 caissons MG 117



● **MG 106S/BC**
Banco dotato di 1 cassettera MG 117
e 1 cassettera MG 118
*Bench with 1 chest of drawers MG 117 and
1 MG 118* | *Etabli avec 1 caisson MG 117
et 1 caisson MG 118*

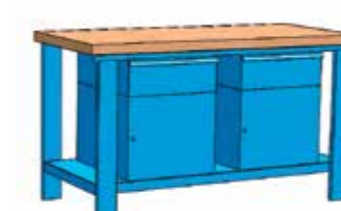

● **MG 106S/CC**
Banco dotato di 2 cassette MG 118
Bench with 2 chests of drawers MG 118 |
Etabli avec 2 caissons MG 118

MG 107S

Banchi componibili con piano in legno

Modular benches with top made of wood | *Etablis à élément avec plateau en bois*

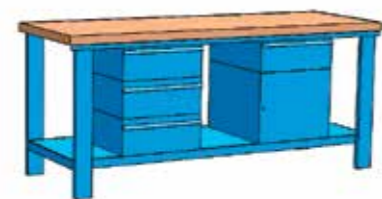

● **MG 107S/BC**
Banco dotato di 1 cassettera MG 117 e 1 cassettera MG 118
Bench with 1 chest of drawers MG 117 and 1 MG 118 |
Etabli avec 1 caisson a 3 tiroirs MG 117 et 1 caisson MG 118

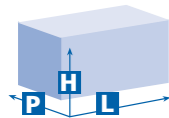

DIMENSIONI BANCO *bench dimensions* / *dimensions établi*

(L) larghezza 2000 mm	(P) profondità 700 mm	(H) altezza 885 mm
--------------------------	--------------------------	-----------------------

PORTATA *Load capacity* / *Charge* 500 kg

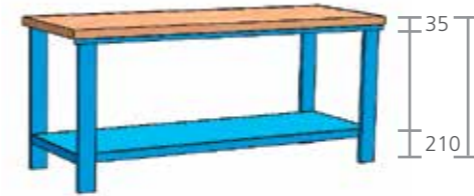

● **MG 107S**
Banco senza cassetti
Bench without drawers |
Etablis sans tiroirs

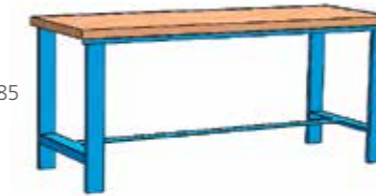

● **MG 107STR**
Banco dotato di traversa poggiatesta
Bench with footrest crossbar |
Etabli avec barre repose pieds

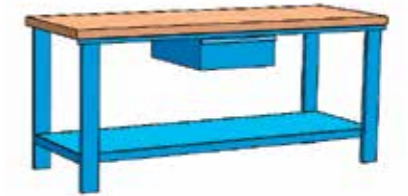

● **MG 107S/A**
Banco dotato di 1 cassettera MG 116
Bench with 1 chest of drawers MG 116 |
Etabli avec un tiroir MG 116

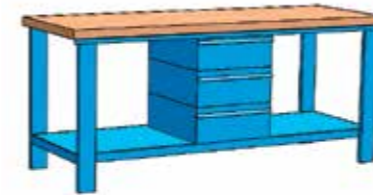

● **MG 107S/B**
Banco dotato di 1 cassettera MG 117
Bench with 1 chest of drawers MG 117 |
Etabli avec un caisson MG 117

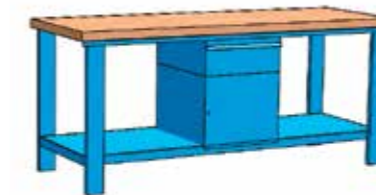

● **MG 107S/C**
Banco dotato di 1 cassettera MG 118
Bench with 1 chest of drawers MG 118 |
Etabli avec un caisson MG 118

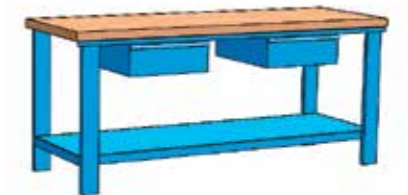

● **MG 107S/AA**
Banco dotato di 2 cassette MG 116
Bench with 2 chests of drawers MG 116 |
Etabli avec 2 tiroirs MG 116

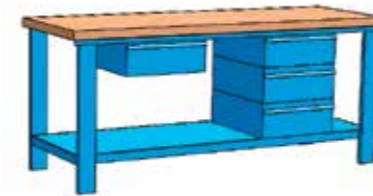

● **MG 107S/AB**
Banco dotato di 1 cassettera MG 116
e 1 cassettera MG 117
*Bench with 1 chest of drawers MG 116 and
1 MG 117* | *Etabli avec 1 tiroir MG 116 et
caisson MG 117*

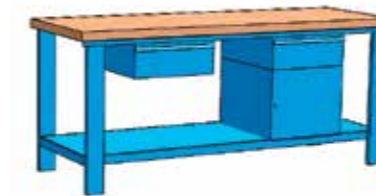

● **MG 107S/AC**
Banco dotato di 1 cassettera MG 116
e 1 cassettera MG 118
*Bench with 1 chest of drawers MG 116 and
1 MG 118* | *Etabli avec 1 tiroir MG 116 et
caisson MG 118*

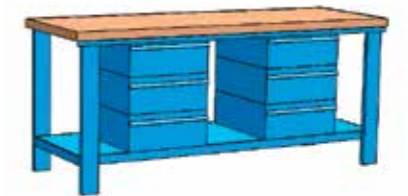

● **MG 107S/BB**
Banco dotato di 2 cassette MG 117
Bench with 2 chests of drawers MG 117 |
Etabli avec 2 caissons MG 117

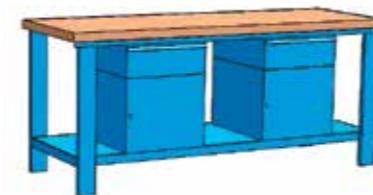

● **MG 107S/CC**
Banco dotato di 2 cassette MG 118
Bench with 2 chests of drawers MG 118 |
Etabli avec 2 caissons MG 118

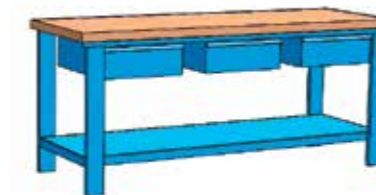

● **MG 107S/AAA**
Banco dotato di 3 cassette MG 116
Bench with 3 chests of drawers MG 116 |
Etabli avec 3 tiroirs MG 116

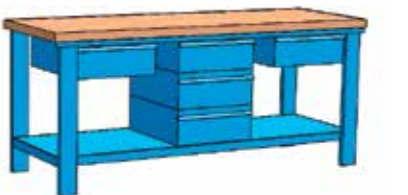

● **MG 107S/ABA**
Banco dotato di 2 cassette MG 116
e 1 cassettera MG 117
*Bench with 2 chests of drawers MG 116
and 1 MG 117* | *Etabli avec 2 tiroirs MG
116 et 1 caisson MG 117*

Tavoli da imballaggio

Packing benches | *Tables d'emballage*



COLORE TAVOLI E CASSETTI

Color for tables and drawers | *Couleur tables et tiroirs*

standard	Grigio RAL 7035
----------	-----------------

COLORE PARETE ATTREZZATA

Color for equipped walls | *Couleur spanneaux équipés*

standard	Blu RAL 5015
----------	--------------

Una linea di tavoli componibili, progettati per l'utilizzo in magazzini, reparti imballaggio/spedizioni, laboratori.

Costruiti con una robusta struttura metallica, forniti in due versioni:

- **Piano di lavoro regolabile in altezza** da mm 783 a mm 1153 tramite gambe telescopiche
- **Piano di lavoro ad altezza fissa mm 878** con gambe non telescopiche

Piano di lavoro in legno nobilitato. Possibilità di attrezzare e personalizzare il tavolo con numerosi accessori.

Nella parte inferiore con:

- Cassetti
- Barre portarotoli (diametro massimo rotolo mm 600)
- Barre poggiapiedi

Nella parte superiore con:

- Mensole portacartoni
- Mensole ad inclinazione variabile
- Pannelli portattrezzi, forati o con asole
- Taglierina

A line of modular tables designed for warehouses, shipping/packing depts., and laboratories.

They are constructed with a sturdy metal structure, and come available in two versions:

- **Worktop with an adjustable height** of 783 mm to 1153 mm, through telescopic legs
- **Worktop with a fixed height of 878 mm** with non-telescopic legs.

Worktop with a laminated wood surface. Possibility of equipping and personalizing the table with numerous accessories.

The lower area includes:

- Drawers
- Roll holder (maximum roll size 600 mm)
- Footrest crossbar

The upper area includes:

- Shelves for storing boxes
- Shelves with a variable angle
- Tool-holder panels, perforated or with slotted holes
- A cutter

Une ligne de tables modulables, conçues pour une utilisation dans les entrepôts, rayons emballage/envois, laboratoires.

Construites avec un châssis robuste en métal, fournies en deux versions:

- **Plan de travail réglable en hauteur** de 783 mm à 1153 mm, avec des pieds télescopiques
- **Plan de travail de hauteur fixe 878 mm** avec des pieds non télescopiques.

Plan de travail en bois contreplaqué. Possibilité d'équiper et de personnaliser la table avec de nombreux accessoires.

Dans la partie inférieure avec:

- Tiroirs
- Barres porte-rouleaux (diamètre maximum du rouleau mm 600)
- Barres repose-pieds

Dans la partie supérieure avec:

- Étagères porte-cartons
- Étagères à inclinaison variable
- Panneaux porte-outils, perforés
- Coupeur

PORTATA *Load capacity / Charge* 500 kg



- **MG110 O1** l. 1500 / p. 800 / h. da 783 a 1153
 - **MG111 O1** l. 2000 / p. 800 / h. da 783 a 1153
- Tavolo con porta rotolo
Workbench with roll holder | *Etabli avec dérouler*

Diametro massimo rotolo mm 600
 Roll maximum diameter 600 mm.
 Diamètre max du rouleau mm 600



- **MG110 PA** l. 1500 / p. 800 / h. da 783 a 1153
 - **MG111 PA** l. 2000 / p. 800 / h. da 783 a 1153
- Tavolo con piano inferiore e cassetto MG116
Workbench with lower shelf and 1 drawer MG116 | *Etabli avec plateau inférieure et tiroir MG116*

- **MG110 TA** l. 1500 / p. 800 / h. da 783 a 1153
 - **MG111 TA** l. 2000 / p. 800 / h. da 783 a 1153
- Tavolo con traversa e cassetto MG116
Workbench with footrest crossbar and 1 drawer MG116 | *Etabli avec barre repose-pieds et tiroir MG116*

- **MG110 P** l. 1500 / p. 800 / h. da 783 a 1153
 - **MG111 P** l. 2000 / p. 800 / h. da 783 a 1153
- Tavolo con piano inferiore e gambe regolabili
Workbench with lower shelf and adjustable legs | *Etabli avec plateau inférieure et piétements réglables*

- **MG110 T** l. 1500 / p. 800 / h. da 783 a 1153
 - **MG111 T** l. 2000 / p. 800 / h. da 783 a 1153
- Tavolo con traversa e gambe regolabili
Workbench with footrest bar and adjustable legs | *Etabli avec barre repose-pieds et piétements fixes*

- **MG110 FP** l. 1500 / p. 800 / h. 878
 - **MG111 FP** l. 2000 / p. 800 / h. 878
- Tavolo con piano inferiore e gambe fisse
Workbench with lower shelf and non-telescopic legs | *Etabli avec plateau inférieure et piétements fixes*

- **MG110 FT** l. 1500 / p. 800 / h. 878
 - **MG111 FT** l. 2000 / p. 800 / h. 878
- Tavolo con traversa e gambe fisse
Workbench with footrest bar and non-telescopic legs | *Etabli avec barre repose-pieds et piétements fixes*

Componenti per banchi

Elements for benches | *Pièces détachées pour établis*



- **SAP15 A** l. 1500 / h. 328
Pannelli con asola
Slot-holed panel | *Panneau cranté*

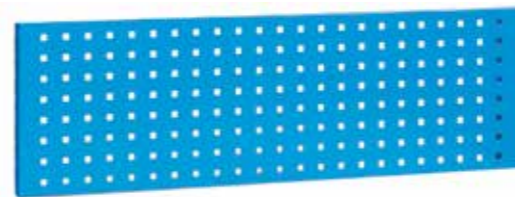

- **SAP15** l. 1500 / h. 328
Pannelli con foro quadro
Square-holed panel | *Panneau trou carré*



- **SAM 03L**
Montante H 1000 mm
Upright H 1000 mm | *Montant H 1000 mm*



- **MG 116G** l. 505 / p. 620 / h. 224
Cassettiera ad 1 cassetto
Chest of drawers with 1 drawer | *Tiroir*



- **SAP 03**
Mensola con braccio snodabile e pannello con asole portacontenitori
Shelf with articulated arm and slotted panel for plastic containers | *Etagère avec bras réglable et panneau cranté pour positionner les conteneurs*



- **SATI 15**
Mensola superiore porta cartone con 8 separatori
Upper cardboard-holder shelf with 8 partitions | *Etagère porte-cartons avec 8 séparateurs.*
- **SATITA15**
Taglierina per tavolo da 1500 mm con luce di taglio di 1150 mm
Cutter for 1500 mm workbench cutter-blade length 1150 mm | *Coupeur pour établi emballage l. 1500 mm section coupante 1150 mm*

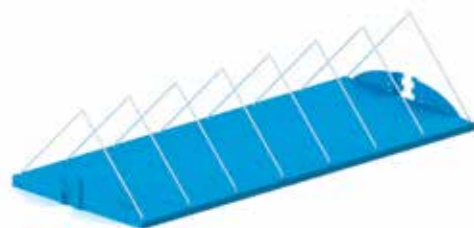

- **SAR 152** l. 1500 / p. 170
Mensola per banco
Shelf for workbench | *Etagère pour établi*

- **SAR 153** l. 1500 / p. 250
Mensola per banco
Shelf for workbench | *Etagère pour établi*

- **SATITA20**
Taglierina per tavolo da 2000 mm con luce di taglio di 1250 mm
Cutter for 2000 mm workbench cutter-blade length 1250 mm | *Coupeur pour établi emballage l. 2000 mm section coupante 1250 mm*

