



filcar.eu

Best Sellers

2024

Aspirazione gas di scarico

Vehicle- exhaust extraction



Distribuzione fluidi & energie

Fluid & energy supply



Aspirazione polveri

Dust extraction

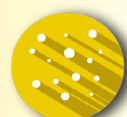

Aspirazione fumi

Fume extraction



Arredo Tecnico

Technical furniture



Aspirazione gas di scarico pag.2

Vehicle- exhaust extraction



Best Sellers

Distribuzione fluidi & energie pag.16

Fluid & energy supply



Best Sellers

Aspirazione polveri pag.20

Dust extraction



Best Sellers

Aspirazione fumi pag.21

Fume extraction



Best Sellers

Arredo Tecnico pag.25

Technical furniture



Best Sellers

Best Sellers

ARROTOLATORI MECCANICI SPRING DRIVEN HOSE REELS



Arrotolatori a molla per aspirazione gas di scarico, adatti ad installazione a soffitto e parete. Completi di tubazione flessibile Eurogas (resistente a temperatura 200°C/192°F) e fermatubo. Senza Bocchetta.

Spring driven hose reels for exhaust gas extraction, suitable to be mounted on ceiling or wall. Fully equipped with EUROGAS flexible hose (temperature resistant 200°/ 192°F), safety hose clamp. Without nozzle.

Ø	mt ft					Ø OUT	 LxLxH	LISTINO €	NETTO €
AR-75/7.5D									
75 mm - 3"	7,5 mt - 25 ft	√	√	-	-	120 mm - 4,7"	80x60x82	-1.655,31€	948,93 €
AR-75/10D									
75 mm - 3"	10 mt - 32 ft	√	√	-	-	120 mm - 4,7"	80x60x82	-1.740,20€	973,50 €
ARC-75/13D									
75 mm - 3"	13 mt - 43 ft	√	√	-	-	120 mm - 4,7"	107x62x84	-2.125,38€	1.139,71 €
ARC-100/7.5D									
100 mm - 4"	7,5 mt - 25 ft	-	-	√	-	120 mm - 4,7"	107x62x84	-1.916,11€	1.046,03 €
ARC-100/10D									
100 mm - 4"	10 mt - 32 ft	-	-	√	-	120 mm - 4,7"	107x62x84	-2.062,27€	1.114,02 €
AC-100/13D									
100 mm - 4"	13 mt - 43 ft	-	-	√	-	150 mm - 6"	140x80x99	-2.961,60€	1.925,04 €
AC-125/10D									
125 mm - 5"	10 mt - 32 ft	-	-	-	√	150 mm - 6"	100x80x99	-2.876,67€	1.869,84 €
AC-125/13D									
125 mm - 5"	13 mt - 43 ft	-	-	-	√	150 mm - 6"	100x80x99	-3.116,15€	2.025,50 €
AC-150/10D									
150 mm 6"	10 mt - 32 ft	-	-	-	√	150 mm - 6"	100x80x99	-3.089,78€	2.008,35 €

Spring
TECHNOLOGY · EVOLUTION



Arrotolatori a molla per aspirazione gas di scarico, adatti ad installazione a soffitto o parete. Completi di tubazione flessibile Eurogas (resistente a temperatura 200°C/192°F), fermatubo ed elettro aspiratore. Senza bocchetta

Spring driven hose reels for exhaust gas extraction, suitable to be mounted on ceiling or wall. Fully equipped with EUROGAS flexible hose (temperature resistant 200°/ 192°F), safety hose clamp, coupled with fan. Without nozzle.

Ø	mt ft						Ø OUT	 LxLxH	LISTINO €	NETTO €
ARA-75/7PB-SB										
75 mm 3"	7,5 mt 25 ft	0,5 HP 0,37 Kw	√	√	-	-	150 mm 6"	120x60x82	-2.491,63€	1.430,62 €
ARA-75/10PB-SB										
75 mm 3"	10 mt 32 ft	0,5 HP 0,37 Kw	√	√	-	-	150 mm 6"	120x60x82	-2.605,27€	1.470,72 €
ARCA-75/13PB-SB										
75 mm 3"	13 mt 43 ft	0,5 HP 0,37 Kw	√	√	-	-	150 mm 6"	141x60x85	-2.931,65€	1.654,64 €
ARCA-100/7PB-SB										
100 mm 4"	7,5 mt 25 ft	0,5 HP 0,37 Kw	-	-	√	-	150 mm 6"	141x60x85	-2.804,81€	1.533,22 €
ARCA-100/10PB-SB										
100 mm 4"	10 mt 32 ft	0,5 HP 0,37 Kw	-	-	√	-	150 mm 6"	141x60x85	-2.896,97€	1.571,91 €
ACA-100/13-SB										
100 mm 4"	13 mt 43 ft	0,5 HP 0,37 Kw	-	-	√	-	150 mm 6"	177X80X104	-3.816,00€	2.480,40 €
ACA-125/10-SB										
125 mm -5"	10 mt 32 ft	1 HP - 0,75 Kw	-	-	-	√	180 mm 7"	140x80x99	-3.875,77€	2.318,87 €
ACA-125/13-SB										
125 mm -5"	13 mt 43 ft	1 HP - 0,75 Kw	-	-	-	√	180 mm 7"	177X80X104	-4.088,70€	2.657,66 €
ACA-150/10-SB										
150 mm 6"	10 mt 32 ft	1 HP - 0,75 Kw	-	-	-	√	180 mm 7"	177X80X104	-4.080,01€	2.651,35 €

Spring
TECHNOLOGY · EVOLUTION

OPTIONAL : MICRO-CTRL : Micro interruttore con quadro elettrico per partenza automatica aspiratore su arrotolatori mod. ARA/ARCA/ACA € 347,88
OPTIONAL : MICRO-CTRL : Micro switch with electrical panel for automatic start of the fan. On hose reels mod. ARA / ARCA / ACA € 347,88

ARROTOLATORI AUTOMATICI AUTOMATIC HOSE REELS

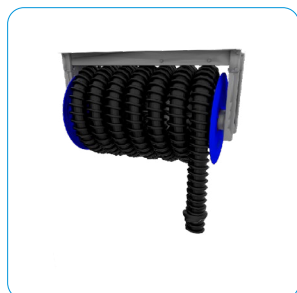

Arrotolatori Automatici per la salita e la discesa della tubazione flessibile, adatti ad installazione a soffitto o parete. Completati di tubazione flessibile Eurogas (resistente a temperatura 200°C/192°F), fine corsa elettronico registrabile, predisposto per interruttore di salita/discesa. Alimentazione 230V monofase. Senza bocchetta.

Automatic hose reels for ascent and descent of the flexible hose, suitable to be mounted on ceiling or wall. Fully equipped with EUROGAS flexible hose (temperature resistant 200°/ 192°F), adjustable electronic limit switch, predisposed fur up/down switch. 230V single phase power supply. Without nozzle.

Ø	mt ft					Ø OUT	LxLxH
DRW-75/7.5-SB							
75 mm - 3"	7,5 mt - 25 ft	√	√	-	-	120 mm - 4,7"	107x62x84
DRW-75/10-SB							
75 mm - 3"	10 mt - 32 ft	√	√	-	-	120 mm - 4,7"	107x62x84
DRW-75/13-SB							
75 mm - 3"	13 mt - 43 ft	√	√	-	-	120 mm - 4,7"	107x62x84
DRW-100/7.5-SB							
100 mm - 4"	7,5 mt - 25 ft	-	-	√	-	120 mm - 4,7"	107x62x84
DRW-100/10-SB							
100 mm - 4"	10 mt - 32 ft	-	-	√	-	120 mm - 4,7"	107x62x84
DRW-100/13-SB							
100 mm - 4"	13 mt - 43 ft	-	-	√	-	150 mm - 6"	123x80x100
DRW-125/10-SB							
125 mm - 5"	10 mt - 32 ft	-	-	-	√	150 mm - 6"	123x80x100
DRW-125/13-SB							
125 mm - 5"	13 mt - 43 ft	-	-	-	√	150 mm - 6"	123x80x100
DRW-150/10-SB							
150 mm - 6"	10 mt - 32 ft	-	-	-	√	150 mm - 6"	123x80x100
DRW-150/13-SB							
150 mm - 6"	13 mt - 43 ft	-	-	-	√	150 mm - 6"	165x80x100

LISTINO €	NETTO €
2.033,13€	1.321,54 €
2.146,77€	1.395,40 €
2.296,53€	1.492,74 €
2.167,92€	1.409,14 €
2.314,98€	1.345,10 €
2.805,95€	1.823,28 €
2.774,40€	1.803,36 €
2.990,40€	1.943,76 €
2.939,39€	1.910,60 €
4.219,61€	2.742,74 €

Darwin
TECHNOLOGY REVOLUTION

OPTIONAL : DRW-A-INT : Pulsante di salita discesa per DRW € 127,92 - OPTIONAL: DRW-A-INT: UP/DOWN button for DRW € 127,92

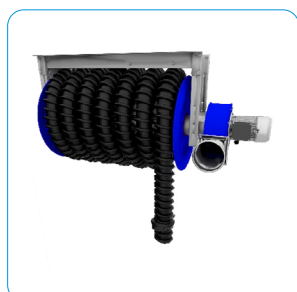

Arrotolatori Automatici per la salita e la discesa della tubazione flessibile, adatti ad installazione a soffitto o parete. Completati di tubazione flessibile Eurogas (resistente a temperatura 200°C/192°F), fine corsa elettronico registrabile, Elettro aspiratore e predisposto per interruttore di salita/discesa. Alimentazione 230V monofase. Senza bocchetta.

Automatic hose reels for ascent and descent of the flexible hose, suitable to be mounted on ceiling or wall. Fully equipped with EUROGAS flexible hose (temperature resistant 200°/ 192°F), adjustable electronic limit switch, coupled with fan and predisposed fur up/down switch. 230V single phase power supply. Without nozzle.

Ø	mt ft						Ø OUT	LxLxH
DRWA-75/7.5-SB								
75 mm - 3"	7,5 mt - 25 ft	0.5 hp - 0.37 kW	√	√	-	-	150 mm - 6"	145x61x85
DRWA-75/10-SB								
75 mm - 3"	10 mt - 32 ft	0.5 hp - 0.37 kW	√	√	-	-	150 mm - 6"	145x61x85
DRWA-75/13-SB								
75 mm - 3"	13 mt - 43 ft	0.5 hp - 0.37 kW	√	√	-	-	150 mm - 6"	145x61x85
DRWA-100/7.5-SB								
100 mm - 4"	7,5 mt - 25 ft	0.5 hp - 0.37 kW	-	-	√	-	150 mm - 6"	145x61x85
DRWA-100/10-SB								
100 mm - 4"	10 mt - 32 ft	0.5 hp - 0.37 kW	-	-	√	-	150 mm - 6"	145x61x85
DRWA-100/13-SB								
100 mm - 4"	13 mt - 43 ft	0.5 hp - 0.37 kW	-	-	√	-	150 mm - 6"	165x80x100
DRWA-125/10-SB								
125 mm - 5"	10 mt - 32 ft	1 hp - 0.75 kW	-	-	-	√	180 mm - 7"	165x80x100
DRWA-125/13-SB								
125 mm - 5"	13 mt - 43 ft	1 hp - 0.75 kW	-	-	-	√	180 mm - 7"	165x80x100
DRWA-150/10-SB								
150 mm - 6"	10 mt - 32 ft	1 hp - 0.75 kW	-	-	-	√	180 mm - 7"	165x80x100
DRWA-150/13-SB								
150 mm - 6"	13 mt - 43 ft	1.5 hp - 1.1 kW	-	-	-	√	180 mm - 7"	165x80x100

LISTINO €	NETTO €
2.866,23€	1.863,05 €
2.979,87€	1.936,92 €
3.129,63€	2.034,26 €
2.961,60€	1.925,04 €
3.105,60€	1.753,68 €
3.652,80€	2.374,32 €
3.840,00€	2.495,99 €
4.056,00€	2.636,40 €
3.956,58€	2.571,78 €
5.115,88€	3.325,32 €

Darwin
TECHNOLOGY REVOLUTION

OPTIONAL : DRWA-QE : Quadro elettrico con interruttore salita/discesa, con fusibili di protezione motore e partenza automatica aspirazione € 471,12
OPTIONAL: DRWA-QE: Electrical panel with up/down switch, with motor protection fuses and automatic start of the fan € 471,12

Best Sellers





ARROTOLATORI AUTOMATICI AUTOMATIC HOSE REELS



Darwin
TECHNOLOGY EVOLUTION

 Arrotolatori Automatici per la salita e la discesa della tubazione flessibile mediante Telecomando, adatti ad installazione a soffitto o parete. Completi di tubazione flessibile Eurogas (resistente a temperatura 200°C/192°F), fine corsa elettronico registrabile, predisposto per partenza automatica aspiratore. Alimentazione 230V monofase. Senza bocchetta.

 Automatic hose reels for ascent and descent of the flexible hose suitable to be mounted on ceiling or wall. Fully equipped with EUROGAS flexible hose (temperature resistant 200°/ 192°F), adjustable electronic limit switch, coupled with fan and predisposed for up/down switch. 230V single phase power supply. Without nozzle.





Ø	mt ft				Ø OUT		LISTINO €	NETTO €	
DRWT-75/7.5-SB									
75 mm - 3"	7,5 mt - 25 ft	√	√	-	120 mm - 4,7"	107x62x84	2.707,61€	1.759,94 €	
DRWT-75/10-SB									
75 mm - 3"	10 mt - 32 ft	√	√	-	120 mm - 4,7"	107x62x84	2.821,25€	1.833,81 €	
DRWT-75/13-SB									
75 mm - 3"	13 mt - 43 ft	√	√	-	120 mm - 4,7"	107x62x84	2.971,01€	1.931,16 €	
DRWT-100/7.5-SB									
100 mm - 4"	7,5 mt - 25 ft	-	-	√	120 mm - 4,7"	107x62x84	2.873,82€	1.867,98 €	
DRWT-100/10-SB									
100 mm - 4"	10 mt - 32 ft	-	-	√	120 mm - 4,7"	107x62x84	3.019,91€	1.760,88 €	
DRWT-100/13-SB									
100 mm - 4"	13 mt - 43 ft	-	-	√	150 mm - 6"	123x80x100	3.479,67€	2.261,79 €	
DRWT-125/10-SB									
125 mm - 5"	10 mt - 32 ft	-	-	√	150 mm - 6"	123x80x100	3.432,00€	2.230,80 €	
DRWT-125/13-SB									
125 mm - 5"	13 mt - 43 ft	-	-	√	150 mm - 6"	123x80x100	3.676,80€	2.389,93 €	
DRWT-150/10-SB									
150 mm - 6"	10 mt - 32 ft	-	-	√	150 mm - 6"	123x80x100	3.625,00€	2.356,25 €	
DRWT-150/13-SB									
150 mm - 6"	13 mt - 43 ft	-	-	√	150 mm - 6"	165x80x100	4.905,21€	3.188,39 €	



Darwin
TECHNOLOGY EVOLUTION

 Arrotolatori Automatici per la salita e la discesa della tubazione flessibile mediante Telecomando, adatti ad installazione a soffitto o parete. Completi di tubazione flessibile Eurogas (resistente a temperatura 200°C/192°F), fine corsa elettronico registrabile, Elettro aspiratore, partenza automatica aspiratore, cavo L=2 mt con spina schuko, termica di protezione motore. Alimentazione 230V monofase. Senza bocchetta.

 Automatic hose reels for ascent and descent of the flexible hose by remote control, suitable to be mounted on ceiling or wall. Fully equipped with EUROGAS flexible hose (temperature resistant 200°/ 192°F), adjustable electronic limit switch, coupled with fan, automatic start/stop of the fan, 2 mt cable with Shuko plug, thermal motor protection. 230V single phase power supply. Without nozzle.

Ø	mt ft					Ø OUT		LISTINO €	NETTO €
DRWTA-75/7.5-SB									
75 mm - 3"	7,5 mt - 25 ft	0.5 hp - 0.37 kW	√	√	-	150 mm - 6"	145x61x85	3.890,04€	2.528,53 €
DRWTA-75/10-SB									
75 mm - 3"	10 mt - 32 ft	0.5 hp - 0.37 kW	√	√	-	150 mm - 6"	145x61x85	4.003,68€	2.602,40 €
DRWTA-75/13-SB									
75 mm - 3"	13 mt - 43 ft	0.5 hp - 0.37 kW	√	√	-	150 mm - 6"	145x61x85	4.153,44€	2.699,74 €
DRWTA-100/7.5-SB									
100 mm - 4"	7,5 mt - 25 ft	0.5 hp - 0.37 kW	-	-	√	150 mm - 6"	145x61x85	4.024,84 €	2.616,14 €
DRWTA-100/10-SB									
100 mm - 4"	10 mt - 32 ft	0.5 hp - 0.37 kW	-	-	√	150 mm - 6"	145x61x85	4.171,00 €	2.438,33 €
DRWTA-100/13-SB									
100 mm - 4"	13 mt - 43 ft	0.5 hp - 0.37 kW	-	-	√	150 mm - 6"	165x80x100	4.561,32€	2.964,86 €
DRWTA-125/10-SB									
125 mm - 5"	10 mt - 32 ft	1 hp - 0.75 kW	-	-	√	180 mm - 7"	165x80x100	4.795,20€	3.116,88 €
DRWTA-125/13-SB									
125 mm - 5"	13 mt - 43 ft	1 hp - 0.75 kW	-	-	√	180 mm - 7"	165x80x100	5.011,20€	3.257,28 €
DRWTA-150/10-SB									
150 mm - 6"	10 mt - 32 ft	1 hp - 0.75 kW	-	-	√	180 mm - 7"	165x80x100	4.963,20€	3.225,29 €
DRWTA-150/13-SB									
150 mm - 6"	13 mt - 43 ft	1.5 hp - 1.1 kW	-	-	√	180 mm - 7"	220x80x100	5.801,49€	3.770,97 €



Tubazione armata con spirale in nylon antischiacciamento per temperatura max 200°C. Particolarmente consigliata per la sua grande flessibilità, leggerezza e resistenza.

Completely Crush-proof nylon coil reinforced hose for max. temperature of 200°C. Strongly recommended for its great flexibility, lightness and resistance.

Ø	mt ft	°C °F
---	----------	----------

EUROGAS-75/10

75 mm - 3"	10 mt - 32 ft	200° C - 392° F
---------------	---------------	--------------------

EUROGAS-75/20

75 mm - 3"	20 mt - 65,6 ft	200° C - 392° F
---------------	-----------------	--------------------

EUROGAS-75/40

75 mm - 3"	40 mt - 131,2 ft	200° C - 392° F
---------------	------------------	--------------------

EUROGAS-100/10

100 mm - 4"	10 mt - 32 ft	200° C - 392° F
----------------	---------------	--------------------

EUROGAS-100/20

100 mm - 4"	20 mt - 65,6 ft	200° C - 392° F
----------------	-----------------	--------------------

EUROGAS-100/40

100 mm - 4"	40 mt - 131,2 ft	200° C - 392° F
----------------	------------------	--------------------

LISTINO € NETTO €

-751,68€	354,97 €
----------	----------

-1.500,86€	700,45 €
------------	----------

-3.002,96€	1.400,90 €
------------	------------

-866,36€	433,33 €
----------	----------

-1.732,72€	854,78 €
------------	----------

-3.464,19€	1.662,08 €
------------	------------

Ø	mt ft	°C °F
---	----------	----------

EUROGAS-125/10

125 mm - 5"	10 mt - 32 ft	200° C - 392° F
----------------	---------------	--------------------

EUROGAS-125/20

125 mm - 5"	20 mt - 65,6 ft	200° C - 392° F
----------------	-----------------	--------------------

EUROGAS-125/40

25 mm - 5"	40 mt - 131,2 ft	200° C - 392° F
---------------	------------------	--------------------

EUROGAS-150/10

150 mm - 6"	10 mt - 32 ft	200° C - 392° F
----------------	---------------	--------------------

EUROGAS-150/20

150 mm - 6"	20 mt - 65,6 ft	200° C - 392° F
----------------	-----------------	--------------------

LISTINO € NETTO €

-953,62€	522,37 €
----------	----------

-1.904,74€	1.032,86 €
------------	------------

-3.809,49€	2.018,24 €
------------	------------

-1.244,07€	652,96 €
------------	----------

-2.481,90€	1.305,92 €
------------	------------



Supporti a muro per tubazione a riposo.

Wall bearings for inactive hoses.

Ø HOSE

SM-20

75 mm - 3" / 100 mm - 4"

SM-30

75 mm - 3" / 100 mm - 4" 125 mm - 5" / 150 mm - 6"

LISTINO € NETTO €

-99,72€	59,83 €
---------	---------

-187,90€	112,75 €
----------	----------



Bocchetta conica in gomma con tappo rimovibile in silicone e ingresso sonda per C.O. (Ø 32 mm).

Rubber nozzle with silicon remouvable cap and intake for C.O. (Ø 32 mm).

Ø HOSE	Ø INLET
--------	---------

BGT-75/140

75 mm - 3"	140 mm - 5"
------------	-------------

BGT-100/140

100 mm - 4"	140 mm - 5"
-------------	-------------

BGT-125/140

125 mm - 5"	140 mm - 5"
-------------	-------------

LISTINO € NETTO €

-156,48€	84,29 €
----------	---------

-141,12€	76,02 €
----------	---------

-135,88€	81,53 €
----------	---------



Bocchetta in gomma con pinza "GRIP" con tampone di protezione della scarico e ingresso sonda per C.O. (Ø 32 mm).

Conical rubber nozzle with "GRIP" clamp, exhaust pipe protection pad and probe input for C.O. (Ø 32 mm).

Ø HOSE	Ø INLET
--------	---------

BGTPG-75/140

75 mm - 3"	140 mm - 5"
------------	-------------

BGTPG-100/140

100 mm - 4"	140 mm - 5"
-------------	-------------

LISTINO € NETTO €

-223,68€	145,40 €
----------	----------

-219,39€	142,61 €
----------	----------



Bocchetta conica in gomma con ingresso sonda per C.O. (Ø 32 mm).



Conical rubber nozzle with intake for C.O. (Ø 32 mm).

Ø HOSE		Ø INLET		LISTINO €	NETTO €
BG-100/200					
100 mm - 4"		200 mm - 8"		-170,78€	111,01 €
BG-125/200					
125 mm - 5"		200 mm - 8"		-174,52€	113,44 €
BG-150/200					
150 mm - 6"		200 mm - 8"		-189,48€	123,16 €



Bocchetta in gomma con pinza "GRIP" e ingresso sonda per C.O. (Ø 32 mm).



Conical rubber nozzle with locking gripper and intake for C.O. (Ø 32 mm).

Ø HOSE		Ø INLET		LISTINO €	NETTO €
BGGP-75/140					
75 mm - 3"		140 mm - 5"		-209,42€	136,12 €
BGGP-100/140					
100 mm - 4"		140 mm - 5"		-209,42€	136,12 €
BGGP-125/140					
125 mm - 5"		140 mm - 5"		-268,01€	174,21 €
BGGP-100/200					
100 mm - 5"		200 mm - 8"		-238,09€	154,76 €
BGGP-125/200					
125 mm - 5"		200 mm - 8"		-238,09€	154,76 €
BGGP-150/200					
150 mm - 5"		200 mm - 8"		-238,09€	154,76 €



Bocchetta conica in gomma con pinza a bloccaggio manuale e ingresso sonda per C.O. (Ø 32 mm).



Conical rubber nozzle with manual locking gripper and probe input for C.O. (Ø 32 mm).

Ø HOSE		Ø INLET		LISTINO €	NETTO €
BG-75/140-PM					
75 mm - 3"		140 mm - 5"		-390,17€	253,61 €
BG-100/140-PM					
100 mm - 4"		140 mm - 5"		-390,17€	253,61 €
BG-125/140-PM					
125 mm - 5"		140 mm - 5"		-402,64€	261,72 €
BG-100/200-PM					
100 mm - 5"		200 mm - 8"		-437,54€	284,40 €
BG-125/200-PM					
125 mm - 5"		200 mm - 8"		-437,54€	284,40 €
BG-150/200-PM					
150 mm - 5"		200 mm - 8"		-437,54€	284,40 €

BOCCHETTE NOZZLES



Bocchetta ovale in gomma per scarichi sdoppiati con ingresso sonda per C.O. (Ø 32 mm).



Oval rubber nozzle for double exhausts with intake for C.O. (Ø 32 mm).

Ø HOSE		Ø INLET		LISTINO €	NETTO €
BGA-75					
75 mm - 3"		167X87 mm		-145,85€	94,80 €
BGA-100					
100 mm - 4"		167X87 mm		-154,57€	100,47 €



Bocchetta ovale in gomma per scarichi sdoppiati pinza a bloccaggio manuale e ingresso sonda per C.O. (Ø 32 mm).



Oval rubber nozzle for double exhaust pipes, with manual locking gripper and probe input for C.O. (Ø 32 mm).

Ø HOSE		Ø INLET		LISTINO €	NETTO €
BGA-75-PM					
75 mm - 3"		167X87 mm		-435,05€	282,78 €
BGA-100-PM					
100 mm - 4"		167X87 mm		-466,21€	303,04 €



Bocchetta ovale in gomma con pinza interna regolabile con tamponi in gomma alle estremità e ingresso sonda per C.O. (Ø 32 mm). Lunghezza leve L=96mm



Oval rubber nozzle with adjustable internal gripper with rubber pads at far ends and probe input for C.O. (Ø 32 mm). Levers length L=96mm

Ø HOSE		Ø INLET		LISTINO €	NETTO €
BGA-75-PGI					
75 mm - 3"		167X87 mm		-723,00€	463,01 €
BGA-100-PGI					
100 mm - 4"		167X87mm		-757,91€	463,01 €

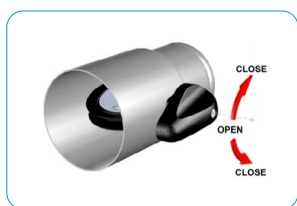

Tronchetto in acciaio verniciato con Serranda manuale a farfalla con doppia guarnizione di tenuta e maniglia in plastica.



Painted steel stub with manual valve, with double seal and plastic handle.

SERR-87		LISTINO €	NETTO €
BG.../140 and BGA		-112,78€	41,55 €
SERR-137			
BG.../200 (no BG-PI e BO-T)		-175,76€	58,58 €



Bocchetta conica in gomma per scarichi integrati nel paraurti dotata di pinza interna regolabile, ingresso sonda per C.O. (Ø 32 mm) e maniglia di movimentazione. Lunghezza leve L=215mm



Conical rubber nozzle for bumper integrated exhaust pipes, with adjustable internal gripper and probe input for C.O. (Ø 32 mm). Levers length L=215mm

Ø HOSE		Ø INLET		LISTINO €	NETTO €
BG-75/200-PI					
75 mm - 3"		200 mm - 8"		-635,75€	381,45 €
BG-100/200-PI					
100 mm - 4"		200 mm - 8"		-635,75€	381,45 €
BG-125/200-PI					
125 mm - 5"		200 mm - 8"		-635,75€	381,45 €
BG-150/200-PI					
150 mm - 6"		200 mm - 8"		-635,75€	381,45 €



 Bocchetta conica in gomma per scarichi integrati nel paraurti dotato di pinza interna e ingresso sonda per C.O. (Ø 32 mm). Allestita con gomma anteriore antigraffio e maniglia di movimentazione. Lunghezza leve L=215mm

 Conical rubber nozzle for hidden exhaust pipes, equipped with internal gripper and intake for C.O. (Ø 32 mm). Equipped with front anti-scratch rubber. Levers length L=215mm

Ø HOSE		Ø INLET		LISTINO €	NETTO €
BGL-75/200-PI					
75 mm - 3"		200 mm - 8"		828,96€	486,75 €
BGL-100/200-PI					
100 mm - 4"		200 mm - 8"		828,96€	486,75 €
BGL-125/200-PI					
125 mm - 5"		200 mm - 8"		828,96€	486,75 €
BGL-150/200-PI					
150 mm - 6"		200 mm - 8"		828,96€	486,75 €

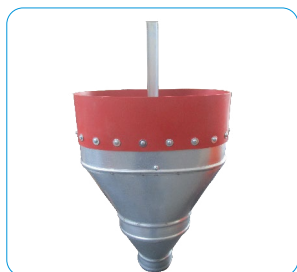

 Bocchetta Ovale in Lamiera adatta per vetture e autocarri, con Pinza Interna Centrale, protezione in gomma e maniglia di movimentazione. Lunghezza leve L= 140 mm

 Iron nozzle suitable for trucks, fix and mobile use, with internal gripper; Rubber protection in all the edges. Levers length L= 140 mm

Ø HOSE		Ø INLET		LISTINO €	NETTO €
BO-T-100/PI-HO-LT					
100 mm - 4"		340x180 mm		890,40€	578,76 €
BO-T-125/PI-HO-LT					
125 mm - 5"		340x180 mm		890,40€	578,76 €
BO-T-150/PI-HO-LT					
150 mm - 6"		340x180 mm		890,40€	578,76 €





 Adattatore ad "Y" per veicoli con doppio scarico, da completare con bocchetta secondo necessità.

 "Y" adaptor for vehicle with double exhaust pipe. To be completed with nozzle as needed.

Ø HOSE		Ø INLET		LISTINO €	NETTO €
Y75-SB					
75 mm - 3"		2x 75 mm - 3"		273,60€	164,16 €
Y100-SB					
100 mm - 4"		2x 100 mm - 4"		317,66€	190,60 €



 Bocchetta carrellata con struttura autoportante, con bivio a Y, tubazione Eurogas 200° e 2 bocchette installate su aste regolabili in altezza, larghezza e inclinazione. Particolarmente adatta per vetture con doppio scarico integrato nel paraurti o per aspirare i gas senza toccare lo scarico. Apertura min-max 640-1850 mm. Altezza min-max 264-844. Inclinazione 11°.

 Wheeled nozzle with self-supporting structure, with Y junction, EUROGAS 200°C flexible hose and 2 nozzles mounted on rods adjustable in height, width and inclination. Suitable for cars with double exhaust pipes integrated in the bumper, or to extract gases without touching the exhaust pipes. Max/min gap 640-1850 mm. Max/min height 264-844 mm. 11° Inclination.

Ø HOSE		Ø INLET			LISTINO €	NETTO €
BRMS-SPE						
100 mm - 4"		200 mm - 8"		BG-100/200	1.305,92€	848,85 €
BRMS-SPE-BG-100/140						
100 mm - 4"		140 mm - 5,5"		BG-100/140	1.289,00€	837,85 €
BRMS-SPE-BGL-100/200						
100 mm - 4"		200 mm - 8"		BGL-100/200	1.569,12€	1.006,16 €

BOCCHETTE NOZZLES



 Depuratore per gas di scarico adatto per autovetture e veicoli commerciali, dotato di 0,15 mt di EUROGAS Ø 100 per accoppiamento a qualsiasi bocchetta Ø 100.

 Exhaust gas depurator suitable for passenger cars and commercial vehicles, equipped with 0.15 mt EUROGAS Ø 100 for coupling to any Ø 100 nozzle.

 HOSE

FUMOSTOP-FLEX
100 mm - 4"

LISTINO €	NETTO €
333,60€	216,84 €



 Bocchetta completa di filtro con carboni attivi per gas di scarico e ingresso sonda per C.O. (Ø 32 mm).

 Nozzle complete with active coal filter for exhaust gas and C.O. (Ø 32 mm) probe inlet.

 INLET

CARATTERISTICHE
CHARACTERISTICS

FUMOSTOP-BGT	
140 mm - 5,5"	BGT + FUMOSTOP
FUMOSTOP-BGA	
167X87	BGA + FUMOSTOP
FUMOSTOP-BG-PM	
140 mm - 5,5"	BG-PM + FUMOSTOP

LISTINO €	NETTO €
184,49€	119,92 €
201,94€	131,26 €
445,02€	289,26 €



TROTTER



 Aspiratore mobile carrellato per estrazione gas di scarico, montato su asta regolabile in altezza. Dotato di bocchetta e interruttore termico. Tubo di espulsione optional.

 Wheeled mobile fan for exhaust gas extraction, mounted on height adjusting rod. Equipped with nozzle and thermal switch. Optional ejection hose.





mt ft FRONT	V Hz *			 LxLxH
-------------------	--------------	---	---	--

TROTTER-50				
-	400 V - 50 Hz	BG-140	0,5HP - 0,35 Kw	107x62x84
TROTTER-50/FI				
0,5 mt - 1,6 ft	400 V - 50 Hz	BGT-100/140	0,5HP - 0,35 Kw	107x62x85

LISTINO €	NETTO €
1.663,03€	997,81 €
1.775,89€	1.065,53 €



mt ft FRONT	V Hz *			 LxLxH
-------------------	--------------	---	---	--

TROTTER-100				
-	400 V - 50 Hz	BG-200	1HP - 0,75 Kw	141x60x85
TROTTER-100/FI				
0,5 mt - 1,6 ft	400 V - 50 Hz	BGT-100/140	1HP - 0,75 Kw	141x60x85

LISTINO €	NETTO €
2.171,51€	1.181,26 €
2.286,19€	1.371,71 €





* Disponibile in versione monofase 230v-50Hz - sovrapprezzo € 100,00
* Available in single phase power 230V-50Hz - extra charge € 100,00



 Aspiratore mobile per estrazione gas di scarico, montato su carrello. Dotato di bocchetta acciaio 230x200 mm, con asta regolabile in altezza ed inclinazione e interruttore termico. Tubo di espulsione optional.

 Mobile exhaust fan for exhaust gas extraction, mounted on trolley. Equipped with steel nozzle 230x200 mm, height and inclination adjusting rod, thermal switch. Optional ejection hose.

mt ft FRONT	V Hz *			 LxLxH
-------------------	--------------	---	---	---

TROTTER-100/S				
1 mt - 3,2 ft	400 V - 50 Hz	BC-AU-II/100	1HP - 0,75 Kw	80x80x98
TROTTER-150/S				
1 mt - 3,2 ft	400 V - 50 Hz	BC-AU-II	1,5 HP - 1,1 Kw	80x80x98

LISTINO €	NETTO €
-2.659,83€	1.573,40 €
-2.686,34€	1.543,36 €

* Disponibile in versione monofase 230v-50Hz - sovrapprezzo € 100,00
* Available in single Phase power 230V-50Hz - extra charge € 100,00





ACCESSORI	
TROTT.50-TUBO	
Tubo di espulsione Ø 100 mm - 10 mt - Discharge hose Ø 100 mm - 10 mt	
FSC-100	
Ø 100 mm - 4"	
TROTT.100-TUBO	
Tubo di espulsione Ø 150 mm - 10 mt - Discharge hose Ø 150 mm - 10 mt	
TROTT.100S-TUBO	
Tubo di espulsione Ø 150 mm - 10 mt - Discharge hose Ø 150 mm - 10 mt	
TROTT.150S-TUBO	
Tubo di espulsione Ø 150 mm - 10 mt - Discharge hose Ø 150 mm - 10 mt	
FSC-150	
Ø 150 mm - 6"	



LISTINO €	NETTO €
-249,84€	162,40 €
-4,99€	3,24 €
-354,02€	225,57 €
-354,02€	225,57 €
-354,02€	225,57 €
-6,23€	4,05 €

AU-II



 Impianto fisso di aspirazione dei gas di scarico per prova opacimetrica. Completo di aspiratore AL (400V - 50 Hz - 3 Ph), tubazione Eurogas 200°, bocchetta carrellata regolabile in altezza e inclinazione.

 Fixed wall mounted exhaust gas extraction system for opacimeter test. Complete with AL fan (400V - 50 Hz - 3 Ph), EUROGAS 200°C flexible hose, wheeled nozzle adjustable in height and inclination.

Ø HOSE	mt ft	°C °F			Ø OUT	 LxLxH
-----------	----------	----------	---	---	----------	--



AU-II/PRO						LISTINO €	NETTO €	
150 mm - 6"	5 mt - 16,4 ft	200° C - 392° F	BC-AU-II	1,5 HP - 1,1 Kw	180 mm R - 7" R	120x60x82	-2.491,20€	1.494,72 €

LISTINO €	NETTO €
-2.491,20€	1.494,72 €



 Impianto fisso di aspirazione dei gas di scarico per pulizia filtri FAP. Completo di aspiratore AL, tubazione Firegas 400°, bocchetta carrellata regolabile in altezza e inclinazione.

 Fixed wall mounted exhaust gas extraction system for particulate filter cleaning operation. Complete with AL fan, FIREGAS 400°C flexible hose, wheeled nozzle adjustable in height and inclination.

Ø HOSE	mt ft	°C °F			Ø OUT	 LxLxH
-----------	----------	----------	---	---	----------	--

AU-II/FAP						LISTINO €	NETTO €	
150 mm - 6"	5 mt - 16,4 ft	400° C - 752° F	BC-AU-II	1,5 HP - 1,1 Kw	180 mm R - 7" R	120x60x82	-3.199,92€	1.919,95 €

LISTINO €	NETTO €
-3.199,92€	1.919,95 €

ECOARGON-1 ECOARGON-2



Unità fissa a parete per l'aspirazione dei gas di scarico di veicoli di piccola e media cilindrata. Completi di aspiratore in fusione (400V - 50 Hz - 3 Ph), 1 o 2 calate con tubo flessibile Eurogas 200°, bocchetta BGT e supporto a muro.

Fixed wall mounted unit for exhaust gas extraction of small and medium size vehicles. Complete with cast fan (400V - 50 Hz - 3 Ph), 1 or 2, EUROGAS 200°C flexible hose connection, BGT nozzle and wall support.

Ø HOSE	mt ft			Ø OUT	
			*		LxLxH

ECOARG-1-75/5

75 mm - 3"	5 mt - 16,4 ft	BGT-75/140	0,5 HP - 0,35 Kw	75 mm L - 3"L	60x50x92
------------	----------------	------------	------------------	---------------	----------

ECOARG-1-75/7,5

75 mm - 3"	7,5 mt - 25 ft	BGT-75/140	0,5 HP - 0,35 Kw	75 mm L - 3"L	60x50x92
------------	----------------	------------	------------------	---------------	----------

ECOARG-1-75/10

75 mm - 3"	10 mt - 32 ft	BGT-75/140	0,5 HP - 0,35 Kw	75 mm L - 3"L	60x50x92
------------	---------------	------------	------------------	---------------	----------

LISTINO € NETTO €

1.245,31€	700,45 €
-----------	----------

1.413,60€	819,17 €
-----------	----------

1.600,58€	914,14 €
-----------	----------



Ø HOSE	mt ft			Ø OUT	
		x2	*		LxLxH

ECOARG-2-75/5

75 mm - 3"	5 mt - 16,4 ft	BGT-75/140	0,5 HP - 0,35 Kw	75 mm L - 3"L	60x50x92
------------	----------------	------------	------------------	---------------	----------

LISTINO € NETTO €

1.818,73€	973,50 €
-----------	----------

* Disponibile in versione monofase 230v-50Hz - sovrapprezzo € 100,00

* Available in single Phase power 230V-50Hz - extra charge € 100,00

ARGON-1 ARGON-2



Unità fissa a parete per l'aspirazione dei gas di scarico di veicoli di piccola e media cilindrata. Completi di aspiratore AL (400V - 50 Hz - 3 Ph), 1 o 2 calate con tubazione rigida, tubo flessibile Eurogas 200°, bocchetta BGT e supporto a muro.

Fixed wall mounted unit for exhaust gas extraction of small and medium size vehicles. Complete with AL fan (400V - 50 Hz - 3 Ph), 1 or 2 rigid pipe connection, EUROGAS 200°C flexible hose BGT nozzle and wall support.

Ø HOSE	mt ft			Ø OUT	
			*		LxLxH

ARGON-1-75-5

75 mm - 3"	5 mt - 16,4 ft	BGT-75/140	0,5 HP - 0,35 Kw	150 mm R - 6"R	107x62x84
------------	----------------	------------	------------------	----------------	-----------

ARGON-1-75-7

75 mm - 3"	7,5 mt - 25 ft	BGT-75/140	0,5 HP - 0,35 Kw	150 mm R - 6"R	107x62x84
------------	----------------	------------	------------------	----------------	-----------

ARGON-1-100-5

100 mm - 4"	5 mt - 16,4 ft	BGT-100/140	1 HP - 0,75 Kw	180 mm R - 7"R	107x62x84
-------------	----------------	-------------	----------------	----------------	-----------

LISTINO € NETTO €

1.670,40€	1.002,24 €
-----------	------------

1.776,00€	1.065,60 €
-----------	------------

1.968,00€	1.279,21 €
-----------	------------



Ø HOSE	mt ft			Ø OUT	
		x2	*		LxLxH

ARGON-2-75-5

75 mm - 3"	5 mt - 16,4 ft	BGT-75/140	0,5 HP - 0,35 Kw	150 mm R - 6"R	107x62x85
------------	----------------	------------	------------------	----------------	-----------

ARGON-2-75-7

75 mm - 3"	7,5 mt - 25 ft	BGT-75/140	0,5 HP - 0,35 Kw	150 mm R - 6"R	107x62x85
------------	----------------	------------	------------------	----------------	-----------

ARGON-2-100-5

100 mm - 4"	5 mt - 16,4 ft	BGT-100/140	1 HP - 0,75 Kw	180 mm R - 7"R	120x60x82
-------------	----------------	-------------	----------------	----------------	-----------

LISTINO € NETTO €

2.226,24€	1.335,75 €
-----------	------------

2.411,04€	1.446,63 €
-----------	------------

2.515,20€	1.634,88 €
-----------	------------

Best Sellers

ECOSYSTEM1



 Kit per impianto di aspirazione gas di scarico con canalina (*L) ETK e carrelli scorrevoli portatubo. Completo di elettro aspiratore (400V - 50 Hz - 3 Ph) e predisposizione per staffaggio. Lunghezza tubazione flessibile Eurogas 7,5 mt resistente a 200°C / 392° F. 1 Carrello. Senza Bocchetta.

 Kit for exhaust gas extraction system with (*L) ETK aluminum track and sliding carriage. Equipped with fan (400V - 50 Hz - 3 Ph) and fixing set-up. Flexible hose length: 7,5 m, resistant up to 200°C / 392° F. One sliding carriage, without nozzle.

*L mt / ft	N° KST	Ø HOSE		Ø OUT
---------------	--------	-----------	---	----------

ECOSYS-A-6/1-SB-D				
6 mt - 20 ft	3	75 mm - 3"	1 HP - 0,75 Kw	160 mm L - 6"L
ECOSYS-A-9/1-SB-D				
9 mt - 30 ft	4	75 mm - 3"	1 HP - 0,75 Kw	160 mm L - 6"L
ECOSYS-A-12/1-SB-D				
12 mt - 40 ft	5	75 mm - 3"	1 HP - 0,75 Kw	160 mm L - 6"L
ECOSYS-B-6/1-SB-D				
6 mt - 20 ft	3	100 mm - 4"	1 HP - 0,75 Kw	160 mm L - 6"L
ECOSYS-B-9/1-SB-D				
9 mt - 30 ft	4	100 mm - 4"	1 HP - 0,75 Kw	160 mm L - 6"L
ECOSYS-B-12/1-SB-D				
12 mt - 40 ft	5	100 mm - 4"	1 HP - 0,75 Kw	160 mm L - 6"L
ECOSYS-C-9/1-SB-D				
9 mt - 30 ft	4	125 mm - 5"	1,5 HP - 1,1 Kw	160 mm L - 6"L
ECOSYS-C-12/1-SB-D				
12 mt - 40 ft	5	125 mm - 5"	1,5 HP - 1,1 Kw	160 mm L - 6"L
ECOSYS-C-15/1-SB-D				
15 mt - 50 ft	6	125 mm - 5"	1,5 HP - 1,1 Kw	160 mm L - 6"L
ECOSYS-D-12/1-SB-D				
12 mt - 40 ft	5	150 mm - 6"	2 HP - 1,5 Kw	200 mm L - 8"L
ECOSYS-D-15/1-SB-D				
15 mt - 50 ft	6	150 mm - 6"	2 HP - 1,5 Kw	200 mm L - 8"L
ECOSYS-D-18/1-SB-D				
18 mt - 59 ft	7	150 mm - 6"	2 HP - 1,5 Kw	200 mm L - 8"L

LISTINO €	NETTO €
4.083,06 €	2.655,54 €
4.787,99 €	3.112,19 €
5.492,93 €	3.570,41 €
4.219,68 €	2.737,01 €
4.947,17 €	3.217,57 €
5.617,81 €	3.651,58 €
5.842,63 €	3.798,54 €
6.792,51 €	4.415,96 €
7.690,03 €	4.998,52 €
7.009,41 €	4.556,11 €
7.904,44 €	5.137,89 €
9.031,33 €	5.870,36 €





Kit per impianto di aspirazione gas di scarico con canalina (*L) ETK o XTK e carrelli scorrevoli portatubo. Completo di elettro aspiratore (400V - 50 Hz - 3 Ph) e predisposizione per staffaggio. Lunghezza tubazione flessibile 7,5 mt resistente a 200° / 392° F. 2 Carrelli. Senza Bocchetta.



Kit for exhaust gas extraction system with (*L) ETK or XTK aluminum track and sliding carriages. Equipped with fan (400V - 50 Hz - 3 Ph) and fixing set-up. Flexible hose length: 7,5 m, resistant up to 200°C / 392° F. Two sliding carriages, without nozzle.

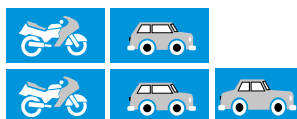

*L mt / ft	N° KST	Ø HOSE		Ø OUT
---------------	--------	-----------	--	----------

ECOSYS-A-6/2-SB-D				
6 mt - 20 ft	3	75 mm - 3"	1,5 HP - 1,1 Kw	160 mm L - 6"L
ECOSYS-A-9/2-SB-D				
9 mt - 30 ft	4	75 mm - 3"	1,5 HP - 1,1 Kw	160 mm L - 6"L
ECOSYS-A-12/2-SB-D				
12 mt - 40 ft	5	75 mm - 3"	1,5 HP - 1,1 Kw	160 mm L - 6"L
ECOSYS-B-6/2-SB-D				
6 mt - 20 ft	3	100 mm - 4"	1,5 HP - 1,1 Kw	160 mm L - 6"L
ECOSYS-B-9/2-SB-D				
9 mt - 30 ft	4	100 mm - 4"	1,5 HP - 1,1 Kw	160 mm L - 6"L
ECOSYS-B-12/2-SB-D				
12 mt - 40 ft	5	100 mm - 4"	1,5 HP - 1,1 Kw	160 mm L - 6"L
ECOSYS-C-12/2-SB-D				
12 mt - 40 ft	4	125 mm - 5"	2 HP - 1,5 Kw	200 mm L - 8"L
ECOSYS-C-15/2-SB-D				
15 mt - 50 ft	5	125 mm - 5"	2 HP - 1,5 Kw	200 mm L - 8"L
ECOSYS-C-18/2-SB-D				
18 mt - 59 ft	6	125 mm - 5"	2 HP - 1,5 Kw	200 mm L - 8"L
ECOSYS-D-15/2-SB-D				
15 mt - 50 ft	5	150 mm - 6"	3 HP - 2,2 Kw	200 mm L - 8"L
ECOSYS-D-18/2-SB-D				
18 mt - 59 ft	6	150 mm - 6"	3 HP - 2,2 Kw	200 mm L - 8"L
ECOSYS-D-21/2-SB-D				
21 mt - 69 ft	7	150 mm - 6"	3 HP - 2,2 Kw	200 mm L - 8"L

LISTINO €	NETTO €
-4.980,68 €	3.237,45 €
-5.675,13 €	3.688,83 €
-6.380,06 €	4.147,04 €
-5.225,63 €	3.396,67 €
-5.959,29 €	3.873,53 €
-6.635,49 €	4.313,06 €
-8.145,03 €	5.294,27 €
-9.311,81 €	6.054,34 €
-10.348,95 €	6.726,82 €
-11.608,86 €	7.545,76 €
-12.924,39 €	8.400,85 €
-14.407,13 €	9.364,63 €



Kit per impianto di aspirazione gas di scarico con canalina (*L) ETK e arrotolatore scorrevole. Completo di elettro aspiratore (400V - 50 Hz - 3 Ph) e predisposizione per staffaggio. Lunghezza tubazione flessibile 10 mt resistente a 200°C / 392° F, 1 Arrotolatore.



Kit for exhaust gas extraction system with (*L) ETK aluminum track and hose reel. Equipped with fan (400V - 50 Hz - 3 Ph) and fixing set-up. Flexible hose length: 10 m, resistant up to 200°C / 392° F. One sliding hose reel.

*L mt / ft	N° KST	Ø HOSE		Ø OUT
---------------	--------	-----------	---	----------

TOPSYS-A-6/1-SB-D				
6 mt - 20 ft	3	75 mm - 3"	1 HP - 0,75 Kw	160 mm L - 6"L
TOPSYS-A-9/1-SB-D				
9 mt - 30 ft	4	75 mm - 3"	1 HP - 0,75 Kw	160 mm L - 6"L
TOPSYS-A-12/1-SB-D				
12 mt - 40 ft	5	75 mm - 3"	1 HP - 0,75 Kw	160 mm L - 6"L
TOPSYS-B-6/1-SB-D				
6 mt - 20 ft	3	100 mm - 4"	1 HP - 0,75 Kw	160 mm L - 6"L
TOPSYS-B-9/1-SB-D				
9 mt - 30 ft	4	100 mm - 4"	1 HP - 0,75 Kw	160 mm L - 6"L
TOPSYS-B-12/1-SB-D				
12 mt - 40 ft	5	100 mm - 4"	1 HP - 0,75 Kw	160 mm L - 6"L
TOPSYS-C-9/1-SB-D				
9 mt - 30 ft	4	125 mm - 5"	1,5 HP - 1,1 Kw	160 mm L - 6"L
TOPSYS-C-12/1-SB-D				
12 mt - 40 ft	5	125 mm - 5"	1,5 HP - 1,1 Kw	160 mm L - 6"L
TOPSYS-C-15/1-SB-D				
15 mt - 50 ft	6	125 mm - 5"	1,5 HP - 1,1 Kw	160 mm L - 6"L
TOPSYS-D-15/1-SB-D				
15 mt - 50 ft	6	150 mm - 6"	2 HP - 1,5 Kw	200 mm L - 8"L

LISTINO €	NETTO €
-6.182,40€	4.018,56 €
-6.883,20€	4.474,08 €
-7.968,00€	5.179,20 €
-6.292,80€	4.090,32 €
-6.993,60€	4.545,84 €
-7.704,00€	5.007,60 €
-8.356,80€	5.431,92 €
-9.187,20€	5.971,68 €
-10.022,40€	6.514,56 €
-9.104,34€	5.917,82 €



TOPSYSTEM2



Kit per impianto di aspirazione gas di scarico con canalina (*L) ETK o XTK e arrotolatori scorrevoli. Completo di elettro aspiratore (400V - 50 Hz - 3 Ph) e predisposizione per staffaggio. Lunghezza tubazione flessibile 10 mt resistente a 200° / 392° F. 2 Arrotolatori. Senza Bocchetta.



Kit for exhaust gas extraction system with (*L) ETK or XTK aluminum track and sliding hose reels. Equipped with fan (400V - 50 Hz - 3 Ph) and fixing set-up. Flexible hose length: 10 m, resistant up to 200°C / 392° F. Two sliding hose reels, without nozzle.

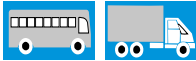
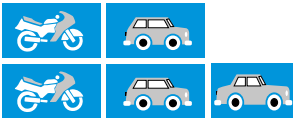

*L mt / ft	N° KST	Ø HOSE		Ø OUT
---------------	--------	-----------	--	----------

TOPSYS-A-6/2-SB-D				
6 mt - 20 ft	3	75 mm - 3"	1,5 HP - 1,1 Kw	160 mm L - 6"L
TOPSYS-A-9/2-SB-D				
9 mt - 30 ft	4	75 mm - 3"	1,5 HP - 1,1 Kw	160 mm L - 6"L
TOPSYS-A-12/2-SB-D				
12 mt - 40 ft	5	75 mm - 3"	1,5 HP - 1,1 Kw	160 mm L - 6"L
TOPSYS-B-6/2-SB-D				
6 mt - 20 ft	3	100 mm - 4"	1,5 HP - 1,1 Kw	160 mm L - 6"L
TOPSYS-B-9/2-SB-D				
9 mt - 30 ft	4	100 mm - 4"	1,5 HP - 1,1 Kw	160 mm L - 6"L
TOPSYS-B-12/2-SB-D				
12 mt - 40 ft	5	100 mm - 4"	1,5 HP - 1,1 Kw	160 mm L - 6"L
TOPSYS-C-12/2-SB-D				
12 mt - 40 ft	5	125 mm - 5"	2 HP - 1,5 Kw	200 mm L - 8"L
TOPSYS-C-15/2-SB-D				
15 mt - 50 ft	6	125 mm - 5"	2 HP - 1,5 Kw	200 mm L - 8"L
TOPSYS-C-18/2-SB-D				
18 mt - 59 ft	7	125 mm - 5"	2 HP - 1,5 Kw	200 mm L - 8"L
TOPSYS-D-15/2-SB-D				
15 mt - 50 ft	6	150 mm - 6"	3 HP - 2,2 Kw	200 mm L - 8"L
TOPSYS-D-18/2-SB-D				
18 mt - 59 ft	7	150 mm - 6"	3 HP - 2,2 Kw	200 mm L - 8"L
TOPSYS-D-21/2-SB-D				
21 mt - 69 ft	8	150 mm - 6"	3 HP - 2,2 Kw	200 mm L - 8"L

LISTINO €	NETTO €
-9.168,00€	5.959,20 €
-9.864,00€	6.411,60 €
-10.564,80€	6.867,12 €
-9.412,80€	6.118,32 €
-10.113,60€	6.573,84 €
-10.814,40€	7.029,36 €
-13.344,00€	8.673,60 €
-14.169,60€	9.210,24 €
-15.000,00€	9.750,00 €
-17.088,00€	11.108,01 €
-18.408,00€	11.965,20 €
-19.776,00€	12.854,40 €

TEST-LINE



Kit per impianto di aspirazione gas di scarico per linee revisione Autovetture o Autocarri. Con canalina (*L) ETK e carrello scorrevole portatubo. Completo di elettro aspiratore (400V - 50 Hz - 3 Ph) e predisposizione per staffaggio, tubazione Eurogas 200°C / 392° F, bilanciere universale, bocchetta con pinza manuale per traino. 1 Carrello.



Kit for exhaust gas extraction system for car and tracks inspection lines. Composed by (*L) ETK aluminum track and sliding carriage. Equipped with fan (400V - 50 Hz - 3 Ph) and fixing set-up, EUROGAS flexible hose resistant up to 200°C / 392° F, universal balancer, nozzle with manual gripper for towing. One sliding carriage.



*L mt / ft	N° KST	Ø HOSE	mt / ft HOSE			Ø OUT
---------------	--------	-----------	-----------------	--	--	----------

TEST-LINE-B-9-D						
9 mt - 30 ft	4	100 mm - 4"	5 mt - 16,4 ft	BGA-100-PM	1HP - 0,75 Kw	160 mm L - 6"L
TEST-LINE-B-12-D						
12 mt - 40 ft	5	100 mm - 4"	5 mt - 16,4 ft	BGA-100-PM	1HP - 0,75 Kw	160 mm L - 6"L
TEST-LINE-VX12-D						
12 mt - 40 ft	5	150 mm - 6"	7,5 mt - 25 ft	BG-150/200-PM	2HP - 1,5 Kw	200 mm L - 8"L
TEST-LINE-VX15-D						
15 mt - 50 ft	6	150 mm - 6"	7,5 mt - 25 ft	BG-150/200-PM	2HP - 1,5 Kw	200 mm L - 8"L

LISTINO €	NETTO €
-5.827,20€	3.787,68 €
-6.556,91€	4.261,99 €
8.340,00€	5.421,00 €
-9.084,93€	5.905,20 €



Pompa manuale a pistone ad azionamento manuale, multifluido, completa di pescante e adattatore 2" portata 35 l/min.

Manual piston pump with manual activation, multifluid, complete with suction pipe and 2" adapter. Flow rate 35 l/min.

ADATTATORE ADAPTER F"	 220 l	FLUIDO ADATTO COMPATIBLE FLUID	USCITA OUTPUT CONNECTION	PORTATA PUMPING FLOW RATE l
-----------------------------	-----------	---	--------------------------------	--------------------------------------

FD-PM-1330B				
2"	200 l	oil, Diesel, antifreeze water	Ø 22 mm	35 l/min

LISTINO €	NETTO €
-86,01€	55,91 €



Pompa pneumatica per fusto o cisterna IBC 1000 a doppio effetto, con ghiera di bloccaggio e pescante. Adatta ad oli di medio/bassa viscosità. Filtro-regolatore-lubrificatore escluso.

Pneumatic pump for drum or tank IBC 1000 double acting, with clamping ring nut and draught. Suitable for medium/low viscosity oils. Filter-regulator-lubricator excluded.

 l		 mm	P.max l/min
-------	--	--------	----------------

OD-PP-4485			
180 - 200 l IBC 1000 l	4:1	765 mm Ø 50	21 l/min

LISTINO €	NETTO €
-504,50€	302,69 €

OD-PP-4491			
180 - 200 l IBC 1000 l	6:1	765 mm Ø 42	15 l/min

-508,83€	305,30 €
----------	----------



Pompa pneumatica murale, completa di pescante per per fusto o cisterna IBC 1000. A doppio effetto, con ghiera di bloccaggio. Adatta ad oli di medio/bassa viscosità. Versione "Long Life" particolarmente adatta per impianti. Per olio o Antigelo. Filtro-regolatore-lubrificatore escluso.

Pneumatic wall pump, complete with suction pipe for drum or IBC 1000 tank. Double-effect, with locking ferrule. Suitable for medium/low viscosity oils. "Long Life" version, especially suitable for oil and antifreeze systems. Filter regulator lubricator excluded.

 l		TUBO DI COLLEGAMENTO CONNECTION PIPE mt	 mm	P.max l/min
-------	--	--	--------	----------------

OD-KIT-2436-L				
200 - 1000 l IBC 1000 l	6:1	2 mt	1035 mm	15 l/min

LISTINO €	NETTO €
-752,00€	451,20€

FD-KIT-2314				
200 - 1000 l IBC	4:1	2 mt	1035 mm INOX	21 l/min

882,06€	529,24 €
---------	----------



IT Kit per distribuzione fluidi (olio o antigelo) composto da pompa pneumatica 4:1 completa di pescante per fusti da 200lt, avvolgitore carenato con tubazione 1/2" L=10 mt, pistola erogatrice con contaltri digitale, salvagocchia murale e tubazione di collegamento da 2 mt. Filtro-regolatore-lubrificatore escluso.

UK Kit for fluid distribution (oil or antifreeze) composed by 4:1 pneumatic pump with suction pipe for 200 lt drum, with 10 m faired hose reel 1/2" r, gun with spout and digital liter counter, wall drip catcher and 2 m flexible connection hose 1/2". Filter regulator lubricator excluded.

		TUBO DI COLLEGAMENTO CONNECTION PIPE mt	AVVOLGITORE HOSE REEL Ø	PISTOLA PISTOL	SALVAGOCCHIA
--	--	---	-------------------------------	-------------------	--------------

OD-KIT-2430					
200 - 1000 l IBC 1000 l	4:1	2 mt	1/2"-L=10 mt	√	√
FD-KIT-2430-AG					
200 - 1000 l IBC	4:1	2 mt	1/2"-L=10 mt	√	√

LISTINO €	NETTO €
-1.706,00€	1.023,6 €
-2.143,00€	1.285,80 €



IT Carrello 4 ruote per fusti da 200 lt, completo di pompa 4:1, flessibile di collegamento 1/2" l=5mt, pistola con beccuccio antigocchia e contaltri digitale con protezione in gomma. Per olio o Antigelo. Filtro-regolatore-lubrificatore escluso.

UK 4 wheels trolley for 200 l drum, complete with 4:1 pump, connection hose 1/2" L=5 mt, gun with anti-drip spout, liter-counter and rubber protection. Suitable for oil or antifreeze. Filter Regulator lubricator excluded.

		TUBO DI COLLEGAMENTO CONNECTION PIPE mt	PISTOLA PISTOL
--	--	---	-------------------

OD-M-2448			
200 l	4:1	5 mt	√
FD-M-2448-AG			
200 l	4:1	5 mt	√

LISTINO €	NETTO €
-1.442,68€	865,61 €
-1.863,81€	1.118,29 €



IT Pistola contaltri con beccuccio di erogazione, antigocchia automatico (versione da olio) e contaltri digitale con display a 5 cifre (resettabile), 7 cifre totali. 1/2" F.

UK Liter counter gun with spout, automatic anti-drip (oil version) and digital litre-counter with 5-digit display (resettable), 7 total digits. 1/2" F.

Pres. max Bar.	P.max l/min
70 Bar	30 l/min
25 Bar	120 l/min

LISTINO €	NETTO €
-334,08€	178,08 €
-432,00€	259,20 €



IT Avvolgitore per Aria e Acqua.

UK Hose reel for Air, Water.

FLUIDO ADATTO COMPATIBLE FLUID	Max Bar.	USCITA OUTLET	TUBO HOSE Ø	mt
Aria/Acqua Air/Water	15 Bar	1/4" M	8/12	10

LISTINO €	NETTO €
-330,00€	198,00 €



 Avvolgitore per Olio, Acqua, Antigelo e Lavavetri.

 Hose reel for Oil, Water, Antifreeze and Windshield cleanser.

FLUIDO ADATTO COMPATIBLE FLUID	Max Bar.	INGRESSO INLET	USCITA OUTLET	TUBO HOSE Ø	mt
-----------------------------------	----------	-------------------	------------------	-------------	----

AVV.OIL-V601210						LISTINO €	NETTO €
Olio/Acqua 40 °C Max Oil/Water 40 °C Max	60 Bar	1/2" M	1/2" M	1/2"	10	708,03 €	424,82 €
AVV.V181310MXE							
Antigelo/ Lavavetri Antifreeze/ Windshield cleanser	18 Bar	1/2" M	1/2" M	13X20	10	769,17 €	461,50 €

OE-M-2092/90

OE-M-2092/65



 Recuperatore mobile a gravità per olio esausto con cappa in metallo di grande diametro e grigliato portafiltri posizionata centralmente, predisposto per svuotamento pneumatico.

 Mobile gravity drainer for exhaust oil with metal bowl (large diameter) and central filter holder grid, set-up for pneumatic discharge.

l	TUBO DI SCARICO PIPE DRAIN mt	CAPPA BOWL Ø
---	----------------------------------	--------------

OE-M-2092/65			LISTINO €	NETTO €
65 l	2 mt	570	555,00 €	338,02 €
OE-M-2092/90				
90 l	2 mt	570	608,00 €	386,42 €

OE-M-2088/90

OE-M-2088/65



 Unità mobile ad azionamento pneumatico per aspirazione olio esausto con precamera, completo di coppa in metallo con grigliato portafiltri, sonde, indicatore di livello.

 I mobile unit with pneumatic drive for exhaust oil extraction, with pre-chamber, complete with metal bowl with filter holder grid, probes, level indicator.

l	TUBO DI ASPIRAZIONE EXTRACTION PIPE mt	TUBO DI SCARICO PIPE DRAIN mt	SONDA PROBES mm
---	---	----------------------------------	--------------------

OE-M-2088/65				LISTINO €	NETTO €
65 l	2 mt	2 mt	5x800 mm	1.069,55 €	592,41 €
OE-M-2088/90					
90 l	2 mt	2 mt	5x800 mm	1.194,84 €	670,35 €

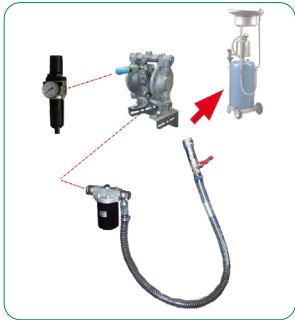

Kit murale per lo svuotamento dei recuperatori mobili di olio esausto. Completo di pompa pneumatica a doppia membrana 1:1, mensola per fissaggio a muro, kit filtro, con tubo di aspirazione l=1mt e innesto rapido (m/f)



Wall kit for emptying the mobile waste oil recovery units. Complete with 1:1 double diaphragm pneumatic pump, wall fixing bracket, filter kit, suction hose L=1 m and quick coupling.

		KIT FILTRO FILTERING KIT	
			mt

OE-KIT-VAC			
1:1	AD-FR1/4-8 13 Bar	1/2" M	1 mt 1/2"

LISTINO €	NETTO €
2.155,00€	1.220,00 €



Cisterne di contenimento per olio esausto, a doppia parete. Interno in polietilene (PE-HD) ed esterno in lamiera zincata. Con 4 fori superiori predisposti per alloggiamento pescanti e aste di livello. Comprensive di indicatore di livello e indicatore danneggiamento parete interna. Pallettizzata.



Waste oil tanks, double walled. The inside in polyethylene (PE-HD) and outside in galvanized sheet. With 4 upper hoses predisposed for suction pipes slot and level rods. Level indicator and internal wall damage indicator included. Palletized.

	DIMENSIONI DIMENSIONS mm	Kg
--	--------------------------------	----

OD-ST-750/2		
750 l	700x1100x1280	65 Kg
OD-ST-1000/2		
1000 l	700x1100x1600	79 Kg
OD-ST-1500/2		
1500 l	760x1630x1860	133 Kg

LISTINO €	NETTO €
1.773,00€	1.152,45 €
1.947,00€	1.265,55 €
3.319,56€	2.157,71 €



Vasche di contenimento a tenuta stagna, verniciate e certificate, per fusti o cisterne



Watertight, painted and certified containment tanks for drums or tanks

	DIMENSIONI DIMENSIONS mm
--	--------------------------------

OD-ST-301-G	
1 DRUM	810x810x350
OD-ST-302-P	
2 DRUMS	1420x710x350
OD-ST-310-G	
1 TANK	1400X1400X550

LISTINO €	NETTO €
807,00€	484,2 €
985,00€	541,51 €
2.085,00€	1.251,00 €



Unità mobile di aspirazione polveri di carteggiatura con doppio motore (Potenza 1000W+1000W), 2 velocità, pulizia manuale a scuotimento, filtro a pannello, sacco raccogli polvere da 50 lt. Dotata di presa di attacco aspirazione e 4 prese (2 Schuko e 2 pneumatiche), tutte dotate di partenza automatica dall'utensile.



Mobile unit for extracting sanding dusts, with double motor (power 1000W + 1000W), 2 speed, manual shaking cleaning, panel filter, 50 lt dust collection bag. Equipped with suction connection and 4 sockets (2 Shuko and 2 pneumatic), all provided with automatic start of the tools.

V	Hz	P max (W)	m³/h	dB(A)	CAP. lt	% FILTR.	kg	UTENSILE TOOLS	PULIZIA MANUALE MANUAL CLEANING	AUTO START
EASY-2										
220/240	50/60	3600	220/260	72	50	99	26	2 MAX	√	√

LISTINO €	NETTO €
2.075,52€	1.175,33 €



Unità di aspirazione fissa con soffiante a canali laterali, con motore 400V trifase. Dotato di 2 prese di aspirazione Ø 50, 2 prese elettriche Interbloccate (No Telecontrol), 2 prese Schuko (si Telecontrol) e 5 prese aria di cui 2 sotto telecontrol. Filtro a cartuccia con sistema di pulizia automatico con getto ad aria compressa e bidone raccolta polveri con sacco da 18 lt. TURBOX-TDA è equipaggiato con 2 armadietti laterali per alloggiamento carteggiatrici e relative tubazioni. Portata max 300 m³/h.



Fixed suction unit with side channel blower, 400V three-phase motor. Equipped with 2 suction inlets Ø 50, 2 interlocked electrical outlets (No Telecontrol), 2 Shuko sockets (with Telecontrol) and 5 air inlets, 2 of them in Telecontrol. Cartridge filter with automatic cleaning system by compressed air jet and dust collection bin with 18 lt bag. TURBOX-TDA is equipped with 2 side cabinets for housing sanders and related piping. Max. flow rate 300 m³/h.

Hp	Kw	V	Hz	in/out Ø	m³/h	dB(A)	CAP. lt	% FILTR.	Kg	UTENSILE TOOLS	PULIZIA AUTOMATICA AUTO CLEAN	AUTO START
TURBOX-3-TD												
3	2,2	400	50	60	300	72	18	99	175	2 MAX	√	-
TURBOX-3T-TD												
3	2,2	400	50	60	300	72	18	99	176	2 MAX	√	√
TURBOX-3T-TDA												
3	2,2	400	50	60	300	72	18	99	258	√	√	√

LISTINO €	NETTO €
11.156,71€	6.992,61 €
11.075,98€	7.122,01 €
14.101,09€	8.460,65 €



Kit di aspirazione polveri di carteggiatura per doppia zona di preparazione composto da braccio articolato BP e unità aspirante modello EASY2 per max 2 utensili in contemporanea. Il kit comprende i cavi di collegamento tra braccio e turbina.



Sanding dust extraction kit for double preparation areas, consisting of a BP articulated arm and a EASY2 extractor unit capable of handling a maximum of 2 tools simultaneously. The kit includes the cables for connecting the arm to the extractor unit.



EASY2/BP5-220	
EASY2	BP-5000-C/220
EASY2/BP6-220	
EASY2	BP-6000-C/220
EASY2/BP7-220	
EASY2	BP-7000-C/220

LISTINO €	NETTO €
8.279,65€	5.381,77 €
8.102,42€	5.318,57 €
8.102,42€	5.318,57 €

ASPIRAZIONE FUMI FUME EXTRACTION



MINI-90

NEXT GENERATION



Unità portatile per l'aspirazione e la filtrazione di fumi di saldatura leggera o a stagno. Dotato di cartuccia filtrante, carboni attivi e cavo di collegamento, MINI90-NG è la soluzione pronta all'uso per lavori a banco e di precisione.



Portable unit for filtering and extracting light or tin welding fumes. Equipped with cartridge filter activated carbon cell, connections wire, MINI90-NG is the right solution ready to be used for bench and precision work.

W	V	Hz	m ³ /h	c.f.m.	dB(A)	Carb. kg	% Filtr.	Kg	L Flex
MINI90-NG									
1150	230	50	140	83	73	2	99	18	3 mt

LISTINO €	NETTO €
-1.269,00€	724,19 €



Kit di ricambio completo per MINI90-NG comprensivo di:



Spare parts kit for MINI90-NG including:

MINI90-NG/KIT-FILTRI	N°
MINI90-NG/RIC + MINI90-NG/CONT	1

LISTINO €	NETTO €
-344,29€	224,54 €



ECOMINOR

NEXT GENERATION



Unità carrellata per aspirazione e filtrazione fumi di saldatura con aspiratore da 1,5 HP. Braccio autoportante articolato flessibile modello ARMFLEX Ø 160 L=3 mt incluso. Portata massima 1.400 m³/h. Idoneo per impieghi poco gravosi. Batteria di filtri meccanica composta da filtro metallico, filtro sintetico e/o filtro alta efficienza, carboni attivi.



Wheeled unit for suction and filtration of welding fumes with 1.5 HP fan. Flexible articulated arm mod. ARMFLEX Ø 160 L=3 m included. Maximum air flow capacity 1.400 m³/h. Suitable for light duty uses. Mechanical filter battery, consisting of metal filter, synthetic filter and/or high efficiency filter, activated carbon.

HP	phase	V	Hz	m ³ /h	c.f.m.	Carb. kg	% Filtr.	Kg
ECOMINOR-NG-FLEX								
1,5	3P+T	400	50	1400	823	4,5	95	83
ECOMINOR-NG-FLEX-CARB								
1,5	3P+T	400	50	1400	823	10	90	86

LISTINO €	NETTO €
-4.091,34€	1.995,06 €
-4.111,28€	2.000,45 €



ECOMINOR

NEXT GENERATION



Unità carrellata per aspirazione e filtrazione fumi di saldatura con aspiratore da 1,5 HP. Braccio autoportante articolato rigido modello TECHNO Ø 150 L=3 mt incluso. Portata massima 1.400 m³/h. Idoneo per impieghi poco gravosi. Batteria di filtri meccanica composta da filtro metallico, filtro sintetico e/o filtro alta efficienza, carboni attivi. Versione "-C" con cartucce. Disponibile anche in versione con filtro assoluto "HEPA".



Wheeled unit for suction and filtration of welding fumes with 1.5 HP fan. Rigid articulated arm mod. TECHNO Ø 150 L=3 m included. Maximum air flow capacity 1.400 m³/h. Suitable for light duty uses. Mechanical filter battery, composed by metal filter, synthetic filter and/or high efficiency filter, activated carbon. "-C" version, with cartridges. Version with absolut HEPA filter also available.

HP	phase	V	Hz	m ³ /h	c.f.m.	Carb. kg	% Filtr.	Kg
ECOMINOR-NG								
1,5	3P+T	400	50	1400	823	4,5	95	94
ECOMINOR-NG-CARB								
1,5	3P+T	400	50	1400	823	10	90	97
ECOMINOR-NG-C								
1,5	3P+T	400	50	1600	941	-	99,9	94
ECOMINOR-NG-HEPA								
1,5	3P+T	400	50	1400	823	-	100	94

LISTINO €	NETTO €
-4.689,37€	2.241,41 €
-4.704,67€	2.245,55 €
-4.562,86€	2.339,74 €
-4.905,60€	2.707,36 €



Kit di ricambio completo per ECOMINOR-NG comprensivo di:



Spare parts kit for ECOMINOR-NG including:

ECOMINOR-NG/KIT-FILTRI	N°	LISTINO €	NETTO €
ECOMINOR-NG/RIPM + ECOMINOR-NG/RIPS + ECOMINOR-NG/RIF + ECOMINOR-NG/CONT	1	445,00€	311,50 €



Kit di ricambio completo per ECOMINOR-NG-CARB comprensivo di:



Spare parts kit for ECOMINOR-NG-CARB including:

ECOMINOR-NG-CARB/KIT-FILTRI	N°	LISTINO €	NETTO €
ECOMINOR-NG/RIPM + 2 x ECOMINOR-NG/RIPS + ECOMINOR-NG/CONT10	1	414,01€	269,11 €



Kit di ricambio completo per ECOMINOR-NG-C o ECOMINOR-NG-HEPA comprensivo di:



Spare parts kit for ECOMINOR-NG-C or ECOMINOR-NG-HEPA including:

ECOMINOR-NG/CART	N°	LISTINO €	NETTO €
ECOMINOR-NG/CART	1	282,97€	198,08 €
ECOMINOR-NG/CART-HEPA	N°	LISTINO €	NETTO €
ECOMINOR-NG/CART-HEPA	1	806,40€	564,48 €



Unità carrellata per aspirazione e filtrazione fumi di saldatura con aspiratore da 3 HP. Braccio autoportante articolato rigido modello TECHNO Ø 150 L=3 mt incluso. Portata massima 1600 m3/h. Idoneo per impieghi gravosi. Batteria di filtri meccanica composta da filtro metallico, filtro sintetico, filtro alta efficienza, carboni attivi. Versione "200" con braccio Dynamic Ø200 - Portata 2.000 m3/h



Wheeled unit for suction and filtration of welding fumes with 3.0 HP fan. Rigid articulated arm mod. TECHNO Ø 150 L=3 m included. Maximum air flow capacity 1.600 m3/h. Suitable for heavy duty uses. Mechanical filter battery, composed by metal filter, synthetic filter, high efficiency filter and activated carbons. "200" version with DYNAMIC arm Ø200 - Maximum air flow capacity 2.000 m3/h.

HP	phase.	V	Hz	m³/h	c.f.m.	Carb. kg	% Filtr.	Kg
----	--------	---	----	------	--------	----------	----------	----

MASTER-NG-1BR								
3	3P+T	400	50	1600	882	16	95	170
MASTER-NG-200								
3	3P+T	400	50	2000	1176	16	95	220

LISTINO €	NETTO €
6.313,95€	3.948,36 €
7.522,39€	4.056,09 €

MASTER
NEXT GENERATION



Kit di ricambio completo per MASTER-NG comprensivo di:





Spare parts kit For MASTER-NG including:

MASTER-NG/KIT-FILTRI	N°	LISTINO €	NETTO €
MASTER-NG/RIPM + MASTER-NG/RIPS + MASTER-NG/RIF + MASTER-NG/CONT	1	1.111,14€	722,24 €

ASPIRAZIONE FUMI FUME EXTRACTION



 Unità carrellata di aspirazione e filtrazione fumi di saldatura e molatura, polveri fini e grossolane, trucioli di modesta entità. Aspiratore da 1,5 HP. Braccio autoportante articolato rigido modello TECHNO Ø150 L=3 mt incluso. Portata massima 1.550 m³/h. Idoneo per impieghi gravosi. Filtri a cartucce orizzontali IFA/BGIA M PES con sistema di pulizia automatica ad aria compressa in controlavaggio

 Wheeled unit for suction and filtration of welding fumes and grinding fumes, fine and coarse dust, small chips. With 1.5 HP fan. Rigid articulated arm mod. TECHNO Ø 150 L=3 m included. Maximum air flow capacity 1.5500 m³/h. Suitable for heavy duty uses. Horizontal cartridge IFA/BGIA M PES, with automatic backwash compressed air cleaning system.

HP	phase	V	Hz	m ²	m ³ /h	c.f.m.	Carb. kg	% Filtr.	Kg
MINIJET-DF2									
1,5	3P+N+T	400	50	16	1550	1109	-	99,9	170

LISTINO €	NETTO €
-9.958,65€	5.679,88 €



 Kit di aspirazione per fumi di saldatura con braccio articolato autoportante, modello TECHNO Ø 150 mm, con tubi rigidi in alluminio. Dotato di staffa di fissaggio a parete ed elettro aspiratore (400V - 50 Hz - 3 Ph). Versione "920" con prolunga a bandiera.

 Suction kit for welding fumes with self-supporting articulated arm mod. TECHNO Ø 150, with rigid aluminum pipes. Equipped with wall fixing bracket and electric fan (400V - 50 Hz - 3 Ph). "920" version with flag extension.



TECHNO330/150-D					
2,8 mt	3,3 mt	-	150 mm	AL-150	160 L
TECHNO420/150-D					
3,6 mt	4,2 mt	-	150 mm	AL-150	160 L
TECHNO520/200-D					
4,6 mt	5,2 mt	-	150 mm	AL-200	200 L
TECHNO920/300-D					
8,6 mt	4,2 mt	5 mt	150 mm	AL-300	200 L

LISTINO €	NETTO €
-2.511,46€	1.632,45 €
-2.402,05€	1.561,33 €
-3.295,61€	2.142,15 €
-5.813,41€	3.779,94 €



 Kit di aspirazione per fumi di saldatura con braccio articolato autoportante con tubo, modello ARMFLEX Ø 160 mm. Dotato ralla di fissaggio diretto ad elettro aspiratore (400V - 50 Hz - 3 Ph). Versione "720" e "920" con prolunga a bandiera.

 Suction kit for welding fumes with flexible self-supporting articulated arm mod. ARMFLEX Ø 160. Equipped with fifth wheel for direct fixing to electric fan (400V - 50 Hz - 3 Ph). "720" and "920" versions with flag extension.

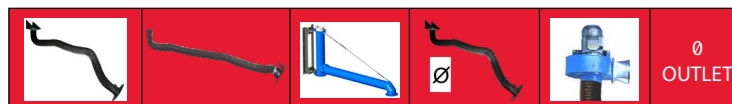

ARMFLEX-330/150-D					
2,8 mt	3 mt	-	160 mm	AL-150	160 L
ARMFLEX-420/150-D					
3,6 mt	4 mt	-	160 mm	AL-150	160 L
ARMFLEX-720/200-D					
6,6 mt	4 mt	3 mt	160 mm	AL-200	200 L
ARMFLEX-920/300-D					
8,6 mt	4 mt	5 mt	160 mm	AL-300	200 L

LISTINO €	NETTO €
-1.944,00€	1.263,60 €
-2.107,20€	1.369,67 €
-5.229,78€	3.399,36 €
-5.377,76€	3.495,55 €



Kit di aspirazione e filtrazione per fumi di saldatura con braccio articolato autoportante, modello TECHNO Ø 150 mm, con tubi rigidi in alluminio. Dotato di staffa di fissaggio a parete, elettro aspiratore (400V - 50 Hz - 3 Ph) e collegamento a filtro. STARFILTER-2000 composto da filtro metallico, filtro sintetico, filtro alta efficienza e carboni attivi.



Suction and filtration kit for welding fumes with self-supporting articulated arm mod. TECHNO Ø 150, with rigid aluminum pipes. Equipped with wall fixing brackets, electric fan (400V - 50 Hz - 3 Ph) and filter connection. STARFILTER-2000 composed by metal filter, synthetic filter, high efficiency filter and activated carbons.



TECHNOSTAR-2000/3						
2,8 mt	3,3 mt	150 mm	AL-200	STAR-2000	95	8
TECHNOSTAR-2000/4						
3,6 mt	4,2 mt	150 mm	AL-200	STAR-2000	95	8

LISTINO €	NETTO €
-4.919,70€	3.197,81 €
-4.800,90€	3.120,58 €

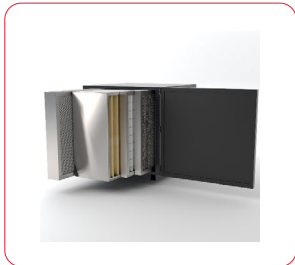

KIT di ricambio completo per STAR-2000 comprensivo di:



Spare parts kit For STAR-2000 including:

STAR-2000/KIT-FILTRI	N°
STAR2000-RIPM + STAR2000-RIPS + STAR-2000-RIF + STAR2000-CONT	1

LISTINO €	NETTO €
-665,19€	432,37 €



Kit per l'aspirazione e l'evacuazione di esalazioni e odori nocivi in ambiente di lavoro. Occorre prevedere sistema di fissaggio della cappa, in base alle esigenze del cliente. Completo di aspiratore (400V - 50 Hz - 3 Ph) in fusione e tubo di collegamento da 5 m Ø120.



Kit for suction and evacuation of harmful fumes and odours in the working environment. It is necessary to provide a system for fixing the hood, according to the customer's needs. Equipped with fan (400V - 50 Hz - 3 Ph) and connection hose L=5 m Ø120.

HP	phase	V	Hz	m ³ /h	c.f.m.	DIM. CAPP	L mt	Ø OUTLET
----	-------	---	----	-------------------	--------	-----------	------	----------

ASPIRVAPOR-75								
0,75	3P+T	400	50	800	412	1000x1200	5	AS-75/C

LISTINO €	NETTO €
-1.903,08€	1.237,00 €



COMPOSITION A:

- Banco di lavoro da 2 mt con piana unica in robusta lamiera d'acciaio verniciata e rivestimento in gomma NBR. Profondità 67 cm.
- 2 Armadietti con anta e ripiani interni, maniglie in acciaio inox, piedini regolabili, serratura con chiave;
- alzata anticaduta con predisposizione per incasso prese e attacchi aria compressa

FORNITO MONTATO



COMPOSITION A:

- 2 m workbench with single top in solid painted sheet steel and NBR rubber coating. 67 cm depth;
- 2 lockers with door and internal shelves, stainless steel handles, adjustable feet, lock with key;
- Fall prevention shelf with compressed air outlets and sockets set-ups.

SUPPLIED ALREADY ASSEMBLED



↑ H	880 mm
→ W	2010 mm
↗ D	670 mm

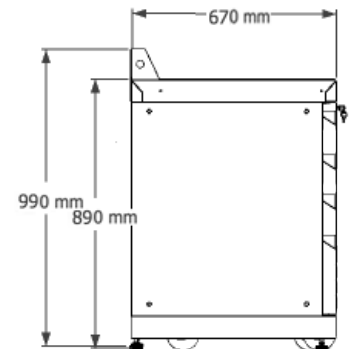

COMPOSITION A

LISTINO €	NETTO €
4.300,00 €	2.600,00 €



COMPOSITION B

- Banco di lavoro da 2 mt con piana unica in robusta lamiera d'acciaio verniciata e rivestimento in gomma NBR. Profondità 67 cm.
- 1 Armadietto con anta e ripiani interni, maniglia in acciaio inox, piedini regolabili, serratura con chiave.
- 1 carrello sottopiana 5 cassetti con sistema antiribaltamento, maniglie di movimentazione, piana di appoggio e contenimento, ruote con freno, serratura con chiave.
- 1 cassetiera fissa con 5 cassetti, guide soft close, maniglie acciaio inox, piedini regolabili, serratura con chiave.
- alzata anticaduta con predisposizione per incasso prese elettriche e attacchi aria compressa

FORNITO MONTATO



COMPOSITION B

- 2 m workbench with single top in solid painted sheet steel and NBR rubber coating. 67 cm depth;
- one cabinet with door and internal shelves, stainless steel handles, adjustable feet, lock with key;
- one 5 drawer under-shelf trolley with anti-tilt system, handling handles, support and containment surface, wheels with brake, lock with key;
- one fixed chest of 5 drawers, soft close guides, stainless steel handles, adjustable feet, lock with key;
- Fall prevention shelf with compressed air outlets and sockets set-ups

SUPPLIED ALREADY ASSEMBLED



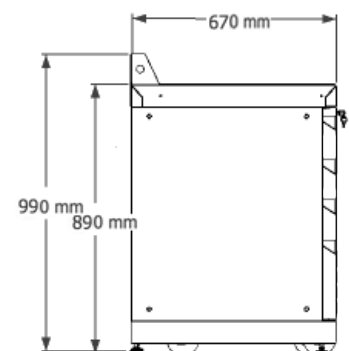

↑ H	880 mm
→ W	2010 mm
↗ D	670 mm



COMPOSITION B

LISTINO €	NETTO €
7.740,00 €	4.650,00 €

-  **COMPOSITION C**
 - Banco di lavoro da 2 mt con piana unica in robusta lamiera d'acciaio verniciata e rivestimento in gomma NBR. Profondità 67 cm.
 - 1 Armadietto con anta e ripiani interni, maniglia in acciaio inox, piedini regolabili, serratura con chiave.
 - 1 cassetiera fissa con 5 cassetti, guide soft close, maniglie acciaio inox, piedini regolabili, serratura con chiave.
FORNITO MONTATO

-  **COMPOSITION C**
 2 m workbench with single top in solid painted sheet steel and NBR rubber coating. 67 cm depth;
 one cabinet with door and internal shelves, stainless steel handles, adjustable feet, lock with key;
 one fixed chest of 5 drawers, soft close guides, stainless steel handles, adjustable feet, lock with key.
SUPPLIED ALREADY ASSEMBLED

↑ H	880 mm
→ W	2010 mm
↙ D	670 mm

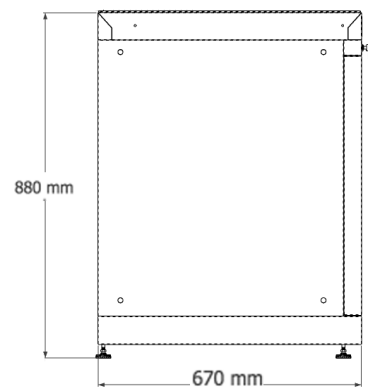

COMPOSITION C

LISTINO €	NETTO €
-4.980,00 €	2.990,00 €

-  **COMPOSITION D**
 - Banco di lavoro da 2 mt con piana unica in robusta lamiera d'acciaio verniciata e rivestimento in gomma NBR. Profondità 67 cm.
 - 1 Armadietto con anta e ripiani interni, maniglia in acciaio inox, piedini regolabili, serratura con chiave.
 - 1 cassetiera fissa con 5 cassetti, guide soft close, maniglie acciaio inox, piedini regolabili, serratura con chiave.
 - Pannello superiore portautensili h 110, con pannellatura con fori a toppa di chiave, serranda in alluminio, maniglie di movimentazione serranda, serratura con chiave e kit vaschette e ganci incluse. Il modulo è realizzato in modo da lasciare libero tutto il piano di lavoro senza perdita di spazio.
FORNITO MONTATO

-  **COMPOSITION D**
 2 m workbench with single top in solid painted sheet steel and NBR rubber coating. 67 cm depth;
 one cabinet with door and internal shelves, stainless steel handles, adjustable feet, lock with key;
 one fixed chest of 5 drawers, soft close guides, stainless steel handles, adjustable feet, lock with key;
 upper tool holder panel h 110, panel with keyhole cut-outs, aluminum shutter and kit of trays and hooks included;
 the composition is designed to leave the entire work surface free without loss of space.
SUPPLIED ALREADY ASSEMBLED

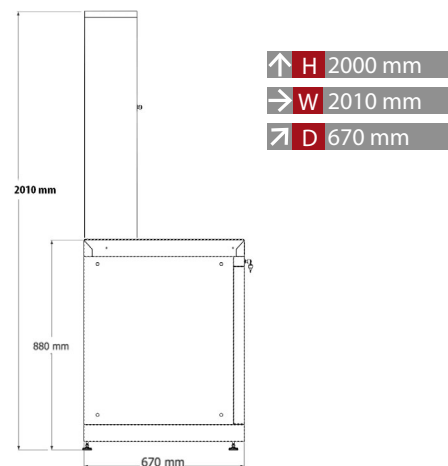

COMPOSITION D

LISTINO €	NETTO €
-8.220,00 €	4.930,00 €

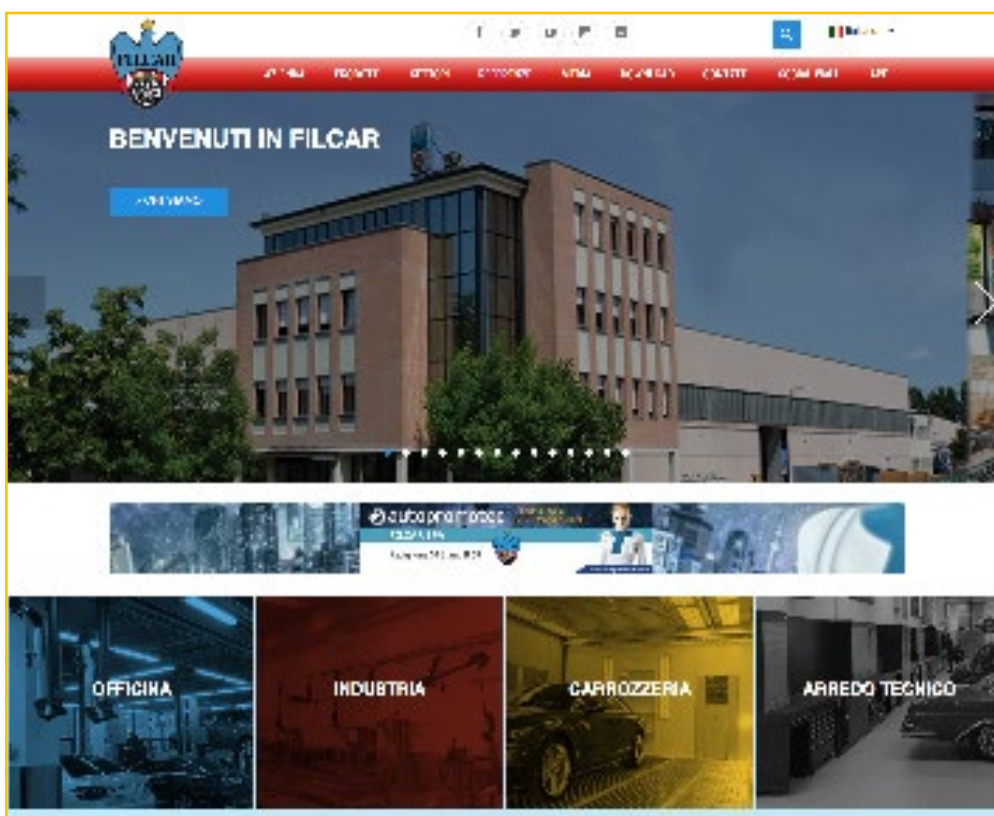

Visita il sito www.filcar.eu, avrai a disposizione tutto il nostro «know how» dedicato all'impianistica per officine per quanto riguarda i settori di aspirazione fumi, polveri, gas, distribuzione fluidi ed energie, arredo tecnico e soluzioni per lo stoccaggio. Sono a vostra completa disposizione immagini di referenze in tutto il mondo, servizi on line di consulenza sulla nostra gamma prodotti. Tradotto in 6 lingue e costantemente aggiornato, il sito internet di FILCAR rimane uno strumento di lavoro effettivo ed affidabile, in cui poter anche curiosare su come lavoriamo e quali sono i nostri valori.

Visit the website www.filcar.eu, you'll have all our 'know-how' dedicated to workshops in the areas of fume, dust, gases, fluid and energy distribution, technical furniture and solutions for the storage. At your disposal references with worldwide pictures, advice online services about our product range. Translated into 6 languages, the FILCAR website remains a real and reliable work instrument, where you can snoop on how we work and see our values.

Visitez notre site internet www.filcar.eu, vous pourrez y découvrir tout notre savoir-faire dédié à l'aménagement des ateliers de réparation dans les secteurs de : l'aspiration des gaz d'échappement ou poussières de ponçage ou fumées, la distribution des énergies et fluides, le mobilier d'atelier et les solutions stockage. Nous mettons à votre totale disposition nos références à travers le monde, ainsi que nos services en ligne de conseil sur nos produits. Traduit en 6 langues et régulièrement mis à jour, notre site internet demeure un outil de travail efficace et fiable où vous pourrez également découvrir notre manière de travailler et d'identifier nos valeurs.

Besuchen Sie die Website www.filcar.eu, werden Sie zur Verfügung haben alle unsere "Know-how" für Workshops gewidmet Anlage als Saug- Sektoren Rauch betrifft, Staub, Gase, Flüssigkeiten und Energieverteilung, Möbel und technische Lösungen für die Lagerung. Ich bin zu Ihrer Verfügung Bilder von Referenzen weltweit, Online-Dienste Beratung in Bezug auf unsere Produktpalette. Übersetzt in 6 Sprachen und ständig auf der Website von FILCAR aktualisiert bleibt eine effektive und zuverlässige Business-Tool, wo man auch auf schnüffeln können, wie wir arbeiten und was unsere Werte.

Visita www.filcar.eu, tendrá todo nuestro "know-how" para planta dedicada a la talleres en cuanto a los sectores de extracción de humos, polvo, gases, líquidos y distribución de energía, muebles y almacenamiento de soluciones técnicas. Están a disposición imágenes de referencias en todo el mundo y servicios sobre línea de consultoría en nuestra gama de productos. Traducido en 6 idiomas y constantemente actualizado, el sitio web de Filcar sigue siendo un herramienta de trabajo eficaz y confiable, donde también se puede espiar a la forma en que trabajamos y cuáles son nuestros valores.

seguici su
follow us on





NOTES

-  **Aspirazione gas di scarico**
Vehicle- exhaust extraction
-  **Distribuzione fluidi & energie**
Fluid & energy supply
-  **Aspirazione polveri**
Dust extraction
-  **Aspirazione fumi**
Fume extraction
-  **Arredo Tecnico**
Technical furniture

Best Sellers



FILCAR S.p.A.
via G. Balla, 18 - 42124
REGGIO EMILIA
ITALY
Tel. +39-0522-941881
Fax. +39-0522-942291
Tel. +39-0522-941167
Fax. +39-0522-494035
www.filcar.eu

FILCAR S.A.R.L.
71, Rue de Malacombe
38070 - ST. QUENTIN
FALLAVIER - LYON
FRANCE
Tel. +33-0474-944064
Fax. +33-0474-942931
www.filcar.fr

BEST SELLERS-ITA-ENG-04/2024

filcar.eu